

# SURFOX 305

User's Guide





# Table of contents

<b>1 Introduction</b>	2	<b>8 Using the marking/etching wand (optional)</b>	12
<b>2 Safety instructions</b>	3	A) Marking kits	12
<b>3 Equipment controls</b>	4	B) Selecting the proper mode	12
A) Control panel pictograms	4	C) SURFOX testing devices	12
B) Front and back view of the machine	5	<b>9 Neutralizing</b>	13
C) Wand control buttons	6	A) Directions for neutralizing SURFOX	
D) Fume elimination system	6	electrolyte cleaning solutions	13
E) Fastening inserts on the large wand	6	B) SURFOX WELD cleaning and neutralization procedure	13
<b>4 Control panel</b>	7	<b>10 Accessories</b>	14
A) Main power switch	7	A) Selection and mounting of the cleaning	15
B) Application Selector	7	B) High conductivity cleaning pads	15
C) Power selector	7	C) PTFE clamp rings	16
D) Electrolyte flow	7	D) SURFOX electrolyte solutions	16
<b>5 Start-up procedure</b>	8	E) Mounting a cleaning pad	16
A) Attaching the wand to the quick-connect adaptor on the machine	8	<b>11 Safety features</b>	17
B) Filling the tank and purging the line	8	A) Sparks on the tip/work piece	17
C) Connecting the air supply	8	B) Internal temperature	17
D) Plugging in the ground clamp	8	C) AC/DC current basics	17
E) Plugging in the power cord	8	D) AC/DC settings on the SURFOX machine	18
<b>6 Using the hand wand to electrochemically clean, polish and passivate</b>	9	E) Welds that cannot be cleaned	18
A) Selecting the proper mode	9	<b>12 Technical data</b>	19
B) Selecting the proper current type, AC or DC on stainless steel	9	<b>13 Warranty and service</b>	19
C) Selecting the proper current type, AC or DC on stainless steel	9	A) Warranty policy	19
D) Selecting the proper pumping mode	9	B) Repair and service	19
E) Cleaning and passivating	9		
F) Neutralizing	9		
<b>7 Using the mini wand (optional) to clean and passivate</b>	10		
A) Selecting the proper mode	10		
B) Selecting the proper current type, AC or DC on stainless steel	10		
C) Selecting the proper current type, AC or DC on stainless steel	10		
D) Selecting the proper pumping mode	10		
E) Cleaning and passivating	10		
F) Neutralizing	10		
G) List of supplies and part numbers	11		

## Introduction

Congratulations on purchasing the finest electrochemical weld cleaning and passivation equipment available today.

**WALTER's SURFOX™** weld cleaning equipment quickly, easily and cost effectively removes the heat tint from heat affected zones on stainless steel and aluminum while completely passivating the stainless steel surface.

SURFOX machines are equipped with self-regulating inverter boards, automatically monitoring and adjusting the current so as to ensure maximum cleaning effectiveness without loss of productivity.

Before starting, please read the SURFOX owner's manual completely as we take you step-by-step through the start-up, operating and maintenance procedures of your new SURFOX equipment. Your new SURFOX machine has been built with extra durability to stand up to the heavy demands of industrial use. However, like any piece of electrical equipment, care and safety should always be taken when using and maintaining this valuable investment. With proper care and maintenance your SURFOX equipment will provide years of dependable service.

To learn more about the other WALTER products, visit our website: **walter.com**

### Operation

The SURFOX machine works by an electrochemical process to clean and passivate welds on stainless steel. SURFOX electrolyte solutions are phosphoric acid based, approved for food industry, and are activated by an electrical current to clean welds. The process takes only a few seconds without damaging or scratching the surface of the parts to be cleaned.

### Your SURFOX machine can clean:

- TIG welds
- Plasma welds
- Laser welds
- Spot welds
- MIG welds (with Pulse technology)

### Basics of passivation:

- The cleaning of the welds is not only for aesthetic purposes but most importantly for passivation.
- Passivation is the treatment of stainless steel surfaces to remove contaminants and promote the formation of a thick and durable protective chromium oxide layer.
- This passive layer will insure the corrosion resistance of stainless steel.
- If passivation is not done properly, stainless steel and heat affected zones may start to rust.

## Safety Instructions

**WALTER** weld cleaning machines are produced in accordance with applicable standards governing the manufacture, performance and safety of industrial products.



**WARNING!** When using these machines, basic safety precautions should always be observed to reduce the risk of fire, electrical shocks and personal injuries.

*Before using this machine, read all Safety and Operating Instructions carefully and save this owner's manual for future reference.*

1. Read this owner's manual to familiarize yourself with this unit's operation, its particular features, applications and limitations.
2. This unit is equipped with a 3-conductor power cord and 3-prong electrical plug, it must be connected to a correspondingly grounded receptacle.
3. Allow a minimum of 8" clearance around the unit to keep all air openings clear of any obstruction. Free airflow through the vent openings is required to prevent the unit from overheating.
4. Keep work area clean and well lit. A cluttered environment invites accidents. Remove any material that may be ignited by sparks. Do not use this tool when flammable liquids or gases are present. Keep handles clean, dry and free from cleaning solution, oil and grease. Do not use in rain, damp or wet locations.
5. Keep children and other persons at a safe distance from the work. Make sure no one is under you when working in high places. Do not let unqualified persons handle this machine.
6. When working, always wear appropriate clothing and safety gear, such as suitable and safety approved chemical resistant gloves, overalls, safety shoes, etc.
7. Always wear approved safety goggles.
8. During the cleaning process, the wand tip and work piece can reach very high temperatures, allow to cool before coming in contact with exposed skin.
9. Avoid inhalation of fumes, use only in well ventilated areas. Use a respirator, if necessary.
10. All electric shocks can be potentially dangerous.
11. Should you encounter an electrical problem, do not use the unit until qualified personnel have inspected the equipment.
12. Never operate the unit with its protective cover removed.
13. Stay alert at all times when handling this unit. Watch what you are doing. Use common sense. Do not operate the tool when you are tired. Never leave it running unattended.
14. Make sure the switch is in its OFF position before plugging in or when moving the unit to avoid unintentional starting.
15. Hold the wand firmly. Do not overreach, maintain good footing and balance at all times.
16. Before use, all parts should be carefully examined to determine that the unit will operate properly and perform its intended function.
17. Parts that are damaged or defective should be properly repaired or replaced by a **WALTER** Factory Service Center or a **WALTER** Authorized Service Center.
18. Do not use the unit if the switch does not turn ON and OFF.
19. Use only the accessories recommended for this system. Always check accessories before starting to work and do not use if damaged.
20. **CAUTION: WALTER SURFOX** electrolyte weld cleaning solutions contain phosphoric acid and may cause burns when not handled properly. Avoid skin contact.  
First aid Wash affected area with water.  
Eye contact Flush with water for 15 minutes lifting eyelids occasionally. Contact physician if necessary.  
Ingestion DO NOT induce vomiting. Rinse mouth, drink plenty of water and get medical attention.  
*Refer to **WALTER** product SDS for complete safety data information.*
21. Use only **WALTER SURFOX** electrolyte weld cleaning solutions with this unit and NEVER mix it with any other products.
22. Store solution in its original container and in a safe place, out of the reach of children and other unqualified persons. Keep container contents clean. Do not reuse SURFOX electrolyte cleaning solutions.
23. Do not touch the wand tip or work piece while working or immediately after use, they may be extremely hot and could cause serious burns.
24. Do not abuse the power cord. Never pull or lift this unit by its cord or yank to disconnect it from the receptacle. Keep the cord away from heat, oil and sharp edges. Inspect the cord periodically, if damaged, have it replaced by a **WALTER** Factory Service Center or a **WALTER** Authorized Service Center.
25. When not in use, switch OFF and unplug the electrical cord and air hose (if connected). It must also remain unplugged when replacing cleaning pads and other accessories, while performing maintenance and before servicing.
26. Store the unit in a dry safe place, out of the reach of children and other unqualified persons.

# 2

## Voltage/Amperage

Before connecting this unit, check that the voltage and amperage shown on the rating plate is the same as the power supply. Operating this unit other than specified on its rating plate may result in personal injury to the user and damage the unit.

## Preventive maintenance

After use, allow the cleaning accessory to cool. Remove the cleaning pad and tungsten or the brush and the adaptor. Neutralize with SURFOX-N and rinse with water and dry. Clean dust and dirt deposits on the outside of the unit. Keep air vents clean and free of any obstructions. Clean the power cord to prevent deterioration and check for possible damage to cord and plug.

**Note:** Damaged cords must be replaced immediately by qualified personnel only. Refer to Spare Parts List for the ordering number.

## Transportation

Before transporting the machine, make sure the cleaning solution reservoir and supply line are completely empty and all connecting lines disconnected. The machine must be carefully packed in a suitable container and properly protected. **WALTER** will not be held responsible for any damages resulting from leaked cleaning solution or rough handling.

## Storage

If the machine is to be stored for any length of time, the cleaning solution reservoir and supply line must be emptied, cleaning accessories removed, neutralized, rinsed and dried. Store in a dry safe place to avoid damage, especially to the electronic components.

## Waste disposal

Dispose of residual waste in compliance with Federal, Provincial, State and local environmental regulations. Refer to **WALTER** Safety Data Sheet of the SURFOX electrolyte cleaning solutions.

## Extension cord

When an extension cord is needed, use wire size 14 (AWG) for up to 50 feet (15 meters) and size 12 (AWG) for 50 to 100 feet (15 to 30 meters).

# 3

## Equipment controls

### A) Control panel pictograms



Outlet for mini wand or marking wand



Indicator for power output (Marking/Mini/Large)



Indicator for internal temperature



Indicator for LOW solution level



Manual pumping mode



Automatic pumping mode

### INOX / STAINLESS

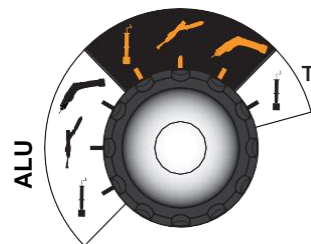

Application Selector

### AC

Cleaning Marking

### DC

Polishing Etching

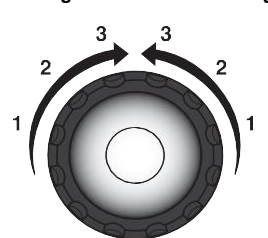

Power Selector

**B) Front and back view of the machine**

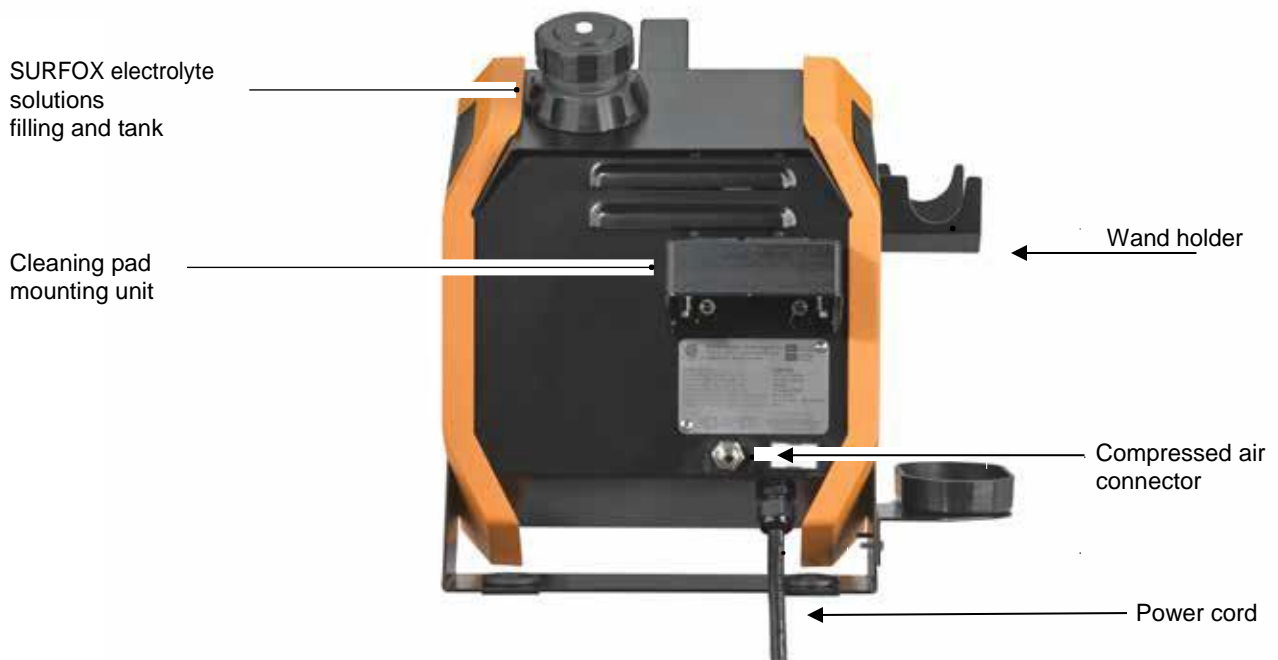



### C) Wand control buttons

The ON button is used to give power to the cleaning accessory. When the pumping mode is set to manual, press the ON button to activate the pump. Press and keep the button pressed to get continuous flow of liquid,

However, if the pumping mode is set to automatic, press the ON button once to activate the pump. To stop the pump, press the OFF button. When finished working with the machine (in either mode) make sure to press the OFF button.

Once the ON button is pressed, there will be continuous power at the tip until the OFF button is pressed.

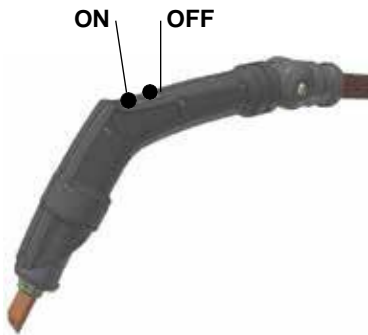

### D) Fume elimination system (patented)

The SURFOX 205 machine comes with the integrated fume elimination system. This system provides for better working conditions. Although the fumes are non-toxic and nonhazardous, they can be uncomfortable when working in confined areas.

To activate this feature simply connect a compressed air line (150 PSI max., 80 PSI min.) to the fitting at the back of the machine. The fume elimination system is automatically activated when the ON button is pressed on the Hand Wand. The fume elimination system is turned OFF when the OFF button on the Hand Wand is pressed. If the fume elimination system is not wanted, simply disconnect the compressed air line.

The working principle is quite simple and highly effective; the air comes out through the small openings behind the tungsten tip. This preset regulated air pressure condenses the vapors out of the air.

### E) Fastening inserts on the large wand

This unit comes with a quick-release adaptor on for the cleaning accessories. The brush holder or tungsten insert may be rotated counter clockwise to release it. Similarly, you can fasten the cleaning accessories by rotating them clockwise. You can also add the 2 x set screws to fix the tungsten or the brush holder permanently.

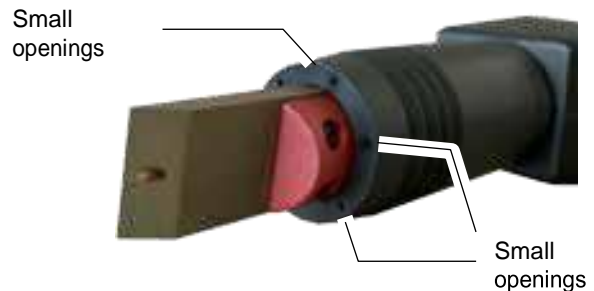
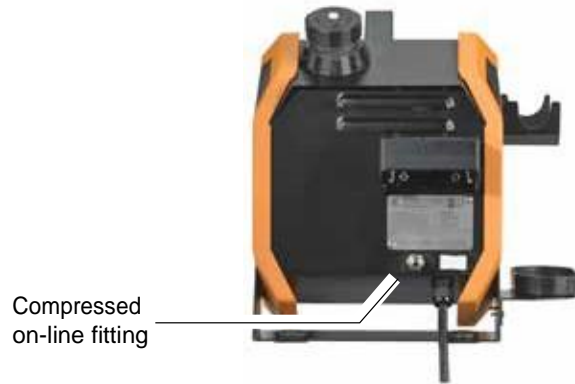



## Control panel



### A) Main power switch

Turns the main power to the unit ON and OFF.

### B) Application Selector

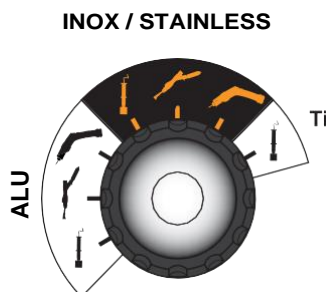

**First Select the Material**  
Aluminum, Stainless or Titanium



**Marking and etching wand selector.** Select this icon when using a marking/etching wand which has been plugged into the accessory outlet.



**Mini wand.** Select this icon when working with the mini-wand plugged into the accessory outlet.



**Large wand selector.** Select this icon when using the hand wand attached to the SURFOX unit.

### D) Electrolyte Flow



Manual  
pumping mode



Automatic  
pumping mode



### C) Power selector

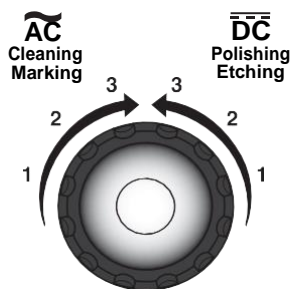

On **Stainless Steel**, Select AC for Cleaning and DC for Polishing. Level 1 has the lowest amperage setting. Level 3 has the highest amperage setting. Level 1 is for TIG welds, Level 2 is for MIG welds, Level 3 should be used with a lot of electrolyte solution with the air system only.

For marking or etching, select AC for marking and DC for etching. Level 1 has the lowest amperage setting. Level 3 has the highest amperage setting.

On **Aluminum**, select AC for cleaning. DC mode will not polish aluminum. For black marking, select AC. Level 1 has the lowest amperage setting. Level 3 has the highest amperage setting. For white etching, select DC.

On **Titanium** for marking, select AC for blue marking. Level 1 has the lowest amperage setting. Level 3 has the highest amperage setting.

## Start-up procedure

### A) Attaching the wand to the quick-connect adaptor on the machine

When an extension cord is needed, use wire size 14 (AWG) for up to 50 feet (15 meters) and size 12 (AWG) for 50 to 100 feet (15 to 30 meters).

Connect the hose to the quick-connect adapter on the machine by turning the part on the hose clock-wise and making sure that the white dot ends in the locked position.

### B) Filling the tank and purging the line

Fill the reservoir in the back of the machine with SURFOX electrolyte solution. The tank holds 1.9 L of SURFOX electrolyte solution. Then purge the unit of the testing solution. Select the highest level of automatic flow and make sure to let liquid flow for 2 minutes. The machine will stop after 30 seconds when no current is flowing through. This means you will have to press the ON button on the large wand 4 times to complete the purge.

### C) Connecting the air supply

Connect the air supply at the back of the machine. Note that the maximum allowed pressure is 150 PSI max., 80 PSI min. (1000 KPa). If the air supply is not plugged into the machine, the machine will still work but there will not be any fume elimination.

### D) Plugging in the ground clamp

Plug the ground clamp at the front of the unit. Attach the clamp to the work piece being cleaned. The cleaning and passivating process will not work if the part is not properly grounded.

### E) Plugging in the power cord

When an extension cord is needed, use wire size 14 (AWG) for up to 50 feet (15 meters) and size 12 (AWG) for 50 to 100 feet (15 to 30 meters).



## Using the hand wand to electrochemically clean, polish and passivate stainless steel or cleaning aluminum

### A) Selecting the proper mode

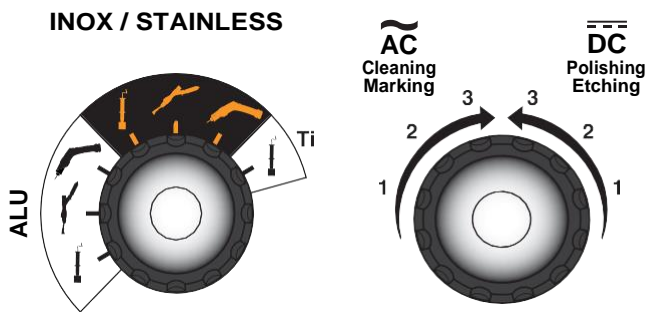

**Large wand selector.** Select this icon when using the hand wand attached to the SURFOX unit.

### B) Selecting the proper current type, AC or DC on stainless steel

Select AC for cleaning and DC for polishing. Level 1 has the lowest amperage setting. Level 3 has the highest amperage setting.

### C) Selecting the proper current type, AC or DC on aluminum

On aluminum, select AC for cleaning. DC mode will not polish aluminum.



**WARNING!** DC mode is used to polish the weld bead to match the mirror finish of the material.



**TIP.** When using the polishing mode (DC), use plenty of SURFOX electrolyte solution.

**Note:** When using DC setting, the SURFOX electrolyte solution will become slightly yellow or will darken.

### D) Selecting the proper pumping mode



Manual pumping mode



Automatic pumping mode

**Manual pumping mode.** Choose the manual pumping mode to control the amount of solution pumping to the tip. Hold the hand wand ON button down to pump solution to the tip. Release the ON button to stop the pumping cycle. Always use enough solution to keep the cleaning accessory wet.

**Automatic pumping mode.** To start the automatic pumping mode, press the ON button on the wand. Once it is activated, it will automatically pump the liquid. The quantity of liquid can be selected from less to more.

### E) Cleaning and passivating

To clean and passivate, press the hand wand ON button. Make sure the cleaning pad is saturated with SURFOX electrolyte cleaning solution before starting to work. If the cleaning accessory is too dry, it will wear prematurely. Start working when solution drips from the cleaning pad.

Do not press hard, let the electrochemical process do the work. Do not use the cleaning accessory like an abrasive pad or a brush.



**WARNING!** When using the machine for the first time, there could be water in the system from factory testing. Adjust the liquid pump setting to automatic at maximum speed and let the liquid drip into a disposal cup for 2 minutes (amount of time required to empty the hose from the tank to the wand). Then, adjust the liquid pump setting back to desired pumping speed.

### F) Neutralizing

1. Remove any excess of SURFOX electrolyte cleaning solution using a soft clean cloth or by rinsing with water.
2. Spray SURFOX-N or FT-100 on the surface.
3. Wipe dry with **another** soft clean cloth to avoid cross contamination or by rinsing with water.

Refer to neutralization procedure in neutralization section for instructions on how to properly neutralize.

Using the mini wand (optional) to clean and passivate

## Using the mini wand (optional) to clean and passivate stainless steel or cleaning aluminum

Use the mini wand to get into tight places where the hand wand cannot go. Plug the mini wand into the accessory outlet on the front panel.

### A) Selecting the proper mode

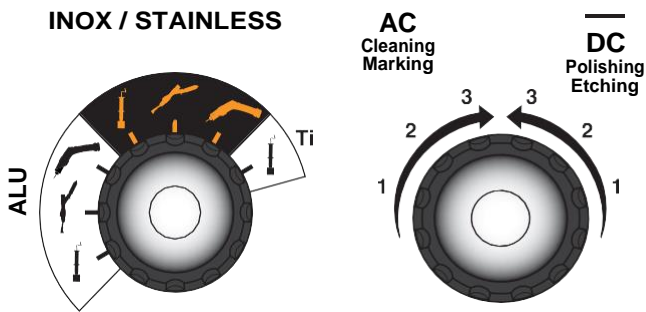

When this mode is selected, it automatically cuts the power to the hand wand, stops the solution pump and the fume elimination system (if connected) from operating. Only power is provided to the mini wand/marketing wand outlet. Be sure work piece is grounded.

### B) Selecting the proper current type, AC or DC on stainless steel

Select AC for Cleaning and DC for Polishing. Level 1 has the lowest amperage setting. Level 3 has the highest amperage setting.

### C) Selecting the proper current type, AC or DC on aluminum

On aluminum, select AC for cleaning. DC mode will not polish aluminum.



**WARNING!** DC mode is used to polish the weld bead to match the mirror finish of the material.



**TIP.** When using the polishing mode (DC), use plenty of SURFOX electrolyte solution.

**Note:** When using DC setting, the SURFOX electrolyte solution will become slightly yellow or will darken.

### D) Manual pumping mode

The mini wand uses a manual pumping mode only. One (1) press equals one (1) pump. To pump more liquid, press repeatedly. See mini wand instructions for more information.

### E) Cleaning and passivating

Screw in SURFOX electrolyte solution 100 ml tube onto the mini wand. Make sure the cleaning pad or brush is saturated with solution before starting to work. If the accessory is too dry, it will wear prematurely. Start working when solution drips from the cleaning pad.

Do not press hard, let the electrochemical process do the work. The accessory is a bridge between the machine and the weld. Do not use the accessory like an abrasive pad.



### F) Neutralizing

1. Remove any excess of SURFOX electrolyte cleaning solution using a soft clean cloth or by rinsing with water.
2. Spray SURFOX-N or FT-100 on the surface.
3. Wipe dry with **another** soft clean cloth to avoid cross contamination or by rinsing with water.

Refer to neutralization procedure in neutralization section for instructions on how to properly neutralize.

### G) List of supplies and part numbers



**The mini wand kit  
(part no.: 54-B 133)**



**Threaded  
brush adaptor  
Part no: 54-B 150**



**SURFOX-T electrolyte  
cleaning solution 100 ml  
Part no: 54-A 001  
6 per package**



**Threaded carbon  
fiber brush  
Part no: 54-B 157**  
To be mounted on  
the mini-wand  
5 per package  
*Ideal for tight corners,  
narrow surfaces and*



**SURFOX-G electrolyte  
cleaning solution 100 ml  
Part no: 54-A 061  
6 per package**

## Using the marking/etching wand (optional)

### A) Marking kits

Standard kit (54-B 080) includes:

- 1 marking/etching wand with graphite insert
- 35 mm X 10 mm and connecting cable
- 20 marking pads
- 5 O-Rings
- 1 SURFOX-M, 100 ml solution
- 1 SURFOX-E, 100 ml solution



PRO kit (54-B 081) includes:

- 1 marking/etching wand with graphite insert
- 35 mm X 10 mm and connecting cable
- 20 marking pads
- 5 O-Rings
- 1 SURFOX-M, 100 ml solution
- SURFOX solution, 100 ml
- 1 Stencil printer and software
- 1 Stencil paper roll 100 mm (W) X 20 m (L)



### B) Selecting the proper mode

Turn the selector knob to the marking/etching wand icon.

Use the marking/etching wand to permanently mark or etch your company name, logo, part number or other desired information onto the surface using permanent or disposable stencils. Plug the marking/etching wand into the accessory outlet on the front panel.

On stainless steel, use AC and SURFOX-M to do a marking; use DC and SURFOX-E to make an etching. On aluminum, use AC and SURFOX-M ALU to make a black marking and DC and SURFOX-E to make an etching. On titanium, use AC and SURFOX-M to do a blue marking.

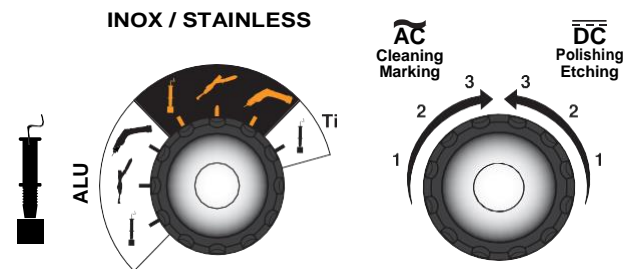

### C) SURFOX testing devices SURFOX Smart Passivation Tester (54-T 011)

To monitor the state of corrosion protection and to ensure proper passivation of the workpiece.

Corrosion resistance of stainless steel is significantly reduced near welds as a result of the heating cycle. Visually, this can be seen as a darkened zone next to the weld. When electro-chemical cleaning is performed on the weld, corrosion risk is reduced but the treated zone still has to be passivated for 24-48 hours before the corrosion protection is fully restored.



### Stainless steel Grade Identification Testing Device (54-T 001)

Informs you on the type of stainless steel you are really working with.

Because it is visually impossible to differentiate 200, 300 and 400 grade stainless steel, the testing device instantly identifies the grade of stainless steel.



TECHNICAL BULLETINS AVAILABLE ON OUR WEB SITE.

## Neutralizing

The SURFOX-N liquid is a specially formulated neutralizer for the SURFOX electrolyte solutions. It is a powerful ready-to-use formula which leaves no residue, is non-toxic, solvent free, water-based and biodegradable.

### A) Directions for neutralizing SURFOX electrolyte cleaning solutions

1. Remove any excess SURFOX electrolyte solution using a soft cloth or rinsing with water.
2. Spray SURFOX-N on the surface.
3. Wipe dry with another soft clean water.

For more information about this product, refer to product SDS.



**WARNING!** Be sure to wipe off all excess SURFOX electrolyte solution from the surface and neutralize otherwise the inorganic salt from the phosphoric acid will adhere to the surface and cause deposits.



#### SURFOX-N neutralizer Part No.

500 ml	54-A 023
5 L	54-A 026
20 L	54-A 027
208 L	54-A 028

### B) SURFOX WELD cleaning and neutralization procedure

Clean the weld using the SURFOX machine and SURFOX electrolyte solutions. Work only 2 feet at a time.

**Note:** The cleaning accessory should be kept moist – **not dripping**.

1. After weld cleaning, use a clean cloth or paper towel and wipe the affected area in a squeegee action from left to right. Then discard the cloth or paper towel. You could also rinse the surface with water.

After cleaning the weld with the SURFOX weld cleaning machine, the electrolyte solution must be neutralized.

1. Spray the affected area with SURFOX-N neutralizer. Allow to sit for 15 seconds on the surface.
2. Use a clean cloth or paper towel and wipe the affected area in a squeegee action from left to right. Then discard the cloth or paper towel. You could also rinse the surface with water.

**Note:** Failure to neutralize or neutralize properly will result in clouding, hazing and dulling of the surface on top of slowing the passivation process.



Permanent salt deposits due to improper neutralization and rinsing.

# 10

## Accessories

### ▼ Replacement wand assemblies

4 m (13') long  
Order no: 54-B 125

9 m (30') long  
Order no: 54-B 126



**Brush Adaptor**  
Part no: 54-B 149  
1 per package



Threaded carbon fiber brushes

**Part no: 54-B 155**

Triangular shape

**Part no: 54-B 156**

Round shape

5 per package

*Ideal for tight corners, narrow surfaces and intricate areas*



### A) Selection and mounting of the cleaning pads and tips

Tungsten tips are made from high quality tungsten alloy material. Other materials will not resist the harsh environment created by the electrochemical process.



**WARNING!** When the insert is too worn, it can cause damage to the cleaning pads.



**TIP.** Resurface the insert using a bench grinding wheel or angle grinder.

**Note:** Be sure to install the O-Ring located at the back of the insert whenever they are changed.

O-Ring



Worn edges on insert.

## Inserts

**Tungsten insert 90°**

**No: 54-B 143**

Use with cleaning pad 54-B 026 or 54-B 040 and clamp ring 54-B 002 or boot 54-B 005.



**Narrow tungsten insert 90°**

**No: 54-B 017**

Use with cleaning pad 54-B 028 or 54-B 041 and clamp ring 54-B 020 or boot 54-B 007.



**Large graphite insert**

**No: 54-B 009**

Use with large cleaning pad 54-B 043

*Ideal for large welded areas and for surface renovation.*





## Accessories

### B) High conductivity cleaning pads

Cleaning pads are made of a complex blend of highly conductive synthetic polymer which is very resistant to wear and which offers excellent thermal stability. For longer life, remove the cleaning pad and neutralize with SURFOX-N at the end of each working day.

Cleaning pads are available in three sizes:

### Features

- Flexible: Can be folded many ways
- Soft on surfaces
- Can be used both sides
- Long lasting
- Highly conductive (4x more conductive than previous generation)



#### Standard cleaning pad

**No: 54-B 026**

Use with insert 54-B 143



#### Inside corners cleaning pad

**No: 54-B 027**

Use with insert 54-B 016



#### Narrow cleaning pad

**No: 54-B 028**

Use with inserts 54-B 017 and 54-B 018



#### Large cleaning pad

**No: 54-B 043**

Use with large graphite insert 54-B 009

# 10

## Accessories

### C) PTFE clamp rings

PTFE clamp rings are designed to hold the cleaning pads on the tungsten inserts.

They are available in two sizes:



**Narrow clamp ring for narrow pads No: 54-B 020**

Use with narrow inserts.  
10 per package.



**Clamp ring for standard cleaning pads No: 54-B 002**

Use with standard inserts.  
10 per package.

### D) SURFOX electrolyte solutions

Surfox electrolyte solutions are specially formulated phosphoric acid cleaning solutions designed to be used only in **WALTER SURFOX** electro cleaning systems.



**SURFOX-G**  
**pH NEUTRAL Electrolyte**  
**Cleaning Solution**

Cleans up to 3-5 feet per minute.

<b>1.5 L / 50.7 oz.</b>	<b>54-A 065</b>
STD Pack: 1 STD Carton: 4	
<b>5 L / 1.3 gal.</b>	<b>54-A 066</b>
STD Pack: 1 STD Carton: 1	
<b>20 L/5.2 gal.</b>	<b>54-A 067</b>
STD Pack: 1 STD Carton: 1	
<b>208 L / 55 gal.</b>	<b>54-A 068</b>
STD Pack: 1 STD Carton: 1	



**SURFOX-T**  
**Heavy-Duty Electrolyte**  
**Cleaning Solution**

Cleans up to 3-5 feet per minute.

<b>1.5 L / 50.7 oz.</b>	<b>54-A 005</b>
STD Pack: 1 STD Carton: 4	
<b>5 L / 1.3 gal.</b>	<b>54-A 006</b>
STD Pack: 1 STD Carton: 1	
<b>20 L/5.2 gal.</b>	<b>54-A 007</b>
STD Pack: 1 STD Carton: 1	
<b>208 L / 55 gal.</b>	<b>54-A 008</b>
STD Pack: 1 STD Carton: 1	

### E) Mounting a cleaning pad

1. Squeeze and insert clamp ring.



2. Insert cleaning pad.



3. Firmly press in tungsten tip.



4. Remove tip with installed pad and clamp ring.



## Safety features

### A) Sparks on the tip/work piece

To avoid short circuits (arcing), the machine automatically stops when a metal to metal contact happens. There is an inverter board that monitors the voltage every millisecond. If the voltage sharply increases creating a short, the system will automatically cut the power to the tip to avoid any damage to the equipment.

To restart the machine, simply press the hand wand ON button.



**WARNING!** To avoid drawing too much amperage and automatically stopping the power to the tip, make sure that you touch only one surface at a time. The machine is set to work at a maximum of 15 amps. If the amperage goes above 15 amps, the machine automatically shuts down.

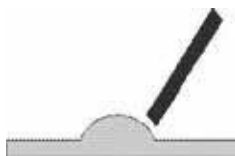

**Example:** On a flat surface, the amperage is around 12 amps. The contact surface area is relatively small.



**Example:** An internal angle, which if you touch 2 sides simultaneously, the contact surface area is doubled, amperage goes above 15 amps and the machine stops.

**Note:** Automatic shut off if ground is not detected within 20 seconds.

### B) Internal temperature

To protect the internal components of the machine, there are temperature sensors inside the machine. If the operating temperature is too high, the machine will shut down, the corresponding LED on the front panel with light and the unit will restart by itself when the temperature reaches an acceptable level. The corresponding LED will then turn off. light on. There is an internal fan inside the machine to keep all the components cool.



**WARNING!** The inside temperature can increase for many reasons: high ambient temperature, lack of proper air circulation around the machine, fluctuations in voltage, electrical set-up in the shop, etc.

### C) AC/DC current basics

**Alternating Current (AC)** flows one way, then the other way, continually reversing direction. An AC voltage is continually changing between positive (+) and negative (-).

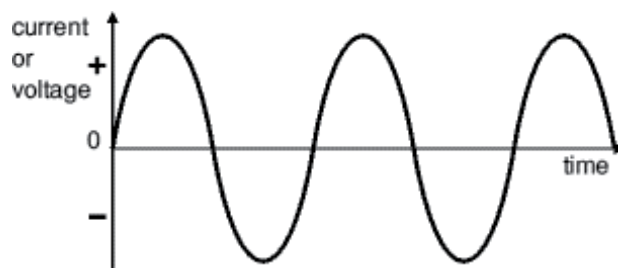

**Direct Current (DC)** always flows in the same direction, but it may increase and decrease. A DC voltage is always positive, but may increase and decrease.

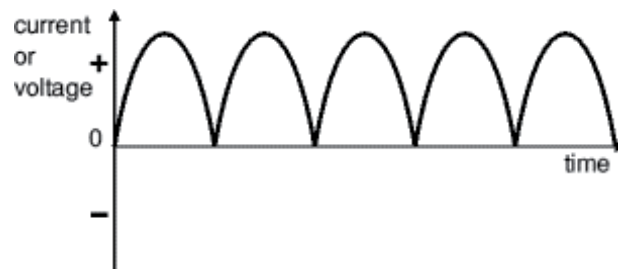

# Safety features

## D) AC/DC settings on the SURFOX machine

Example of cleaning and passivation with SURFOX in AC mode:

*Microscopic view of the material.*

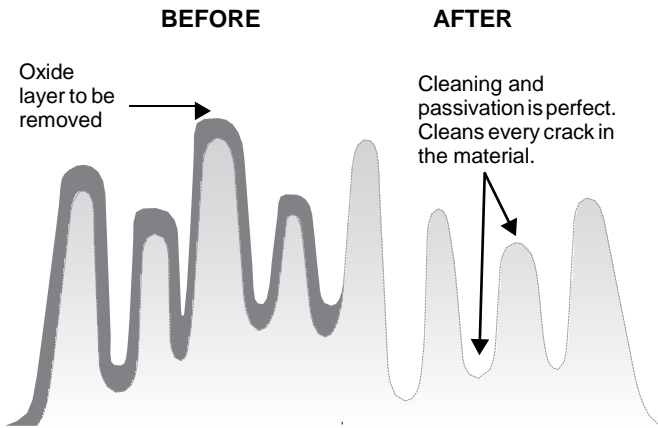

Example of cleaning and passivation with SURFOX in DC mode:

*Microscopic view of the material.*

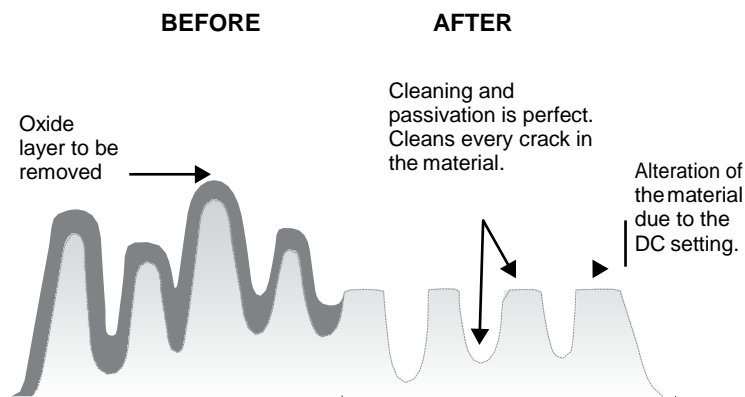

## E) Welds that cannot be cleaned

If the area around the weld is black (not blue) from contamination, this is a problem of high heat generated during the welding process. The contaminated areas do not conduct electricity. If there is no conductivity in the material, the SURFOX system cannot work.

If there are two welds on top of the other, the structure of the material has been seriously altered. These areas may not be cleaned.

The quality of the weld is critical. The better the weld, the easier it will be to clean.

## Technical data

**MODEL:** SURFOX 305

**PART NUMBER:** 54-D 315

**INPUT VOLTAGE:** 120 V, 50/60 Hz

**OUTPUT VOLTAGE:** 12-30 V, AC/DC

**INPUT CURRENT:** 8.0 Amps

**OUTPUT CURRENT:** 30 Amps, AC/DC MAX.

**DIMENSIONS:** 470 mm x 380 mm x 250 mm  
(18.5" x 15" x 9.75")

**RESERVOIR CAPACITY:** 1.9 L

**WEIGHT:** 20.0 kg (44 lbs.)

**INPUT AIR PRESSURE:** 150 PSI max., 80 PSI min.

## Warranty and service

### A) Warranty policy

All **WALTER SURFOX** cleaning systems and accessories are inspected and tested before shipment and are warranted to be free from any defect in material and faulty workmanship. Should any malfunction occur within six (6) months from the date of original purchase, return the complete system prepaid with proof of purchase, to the nearest **WALTER** Factory or Authorized Service Center. If an examination shows that the malfunction was caused by defective material or faulty workmanship, **WALTER** will repair (or at our option, replace the unit) without charge. This warranty does not apply when; normal maintenance is required, repairs or replacements have been made or were attempted by anyone other than **WALTER** authorized service personnel, and does not cover any damage caused by accidents, modifications, use of improper accessories, abuse or misuse, which also includes overloading the tool beyond its rated capacity as well as its continued use after partial failure. No other warranty, written or verbal, is authorized.

In no event shall **WALTER** be liable for any indirect, incidental or consequential damages from the sale of the product. This disclaimer applies both during and after the term of this warranty.

This warranty gives you specific rights. The provisions contained in this warranty are not intended to limit, modify, take away from, disclaim or exclude any warranties set forth in any Provincial or State legislation. To the extent required by law, the provisions in any Provincial, State or Federal legislation with respect to warranties take precedence over the provisions in this warranty.

### B) Repair and service

When shipping:

- Drain the SURFOX electrolyte solution from the reservoir
- Use original shipping case
- Use sufficient packing
- Ship on a small pallet
- Give detailed description of the problem as well as company name, address, phone and fax numbers and contact person

