



DESIGN
AWARD
2016



PowerCure INNOVATION IN ADHESIVE SYSTEMS

BUILDING TRUST



An aerial photograph of a city skyline, likely New York City, featuring a large suspension bridge on the left, a multi-lane highway with traffic in the center, and various skyscrapers in the background under a cloudy sky. A semi-transparent white box is overlaid at the bottom of the image, containing text.

COMMITMENT TO QUALITY, INNOVATION AND CONSISTENCY

Sika Industry and Automotive sets itself apart as a world leader in bonding, sealing, damping, reinforcing and protection solutions by developing state-of-the-art adhesives, sealants, acoustic and protective products for the manufacturing and repair markets.

CONTENT

04 Introduction

06 Positioning of PowerCure vs. existing technologies

08 PowerCure in detail

10 Packaging and mixer

12 Application - Repair

14 Application - Assembly bonding

16 Application - On-site

18 Application - Joint sealing

20 Swissness and partnership



"PowerCure is the result of Sika's focus on finding the perfect solution for our customers. From the first development stages we emphasized the added value for future users. This has allowed us to simplify working steps and to create a novel, best in class, fast-curing sealing and bonding solution."

THOMAS HASLER
CTO SIKA AG

THE BREAKTHROUGH IN ACCELERATED BONDING

Sika's success and lasting reputation are the results of a continued trust in innovation. Fittingly, the core of our business is focused on developing quality, innovative products which provide the best solutions for our customers. It was with this focus on user ergonomics and performance that Sika devised a revolutionary adhesive system called PowerCure. A number of groundbreaking features make it an extremely reliable work companion offering outstanding user comfort.

Protected by more than 13 patents, Sika's PowerCure technology is the ultimate solution for accelerated fast-curing adhesive systems. Based on an application gun, a packaging unit and a mixer nozzle, the system delivers the precision and performance of a high-end pump system for smaller sealing and bonding applications. It is optimized for repair, assembly and on-site bonding applications, as well as joint sealing. PowerCure is a total solution, providing the fastest curing adhesives at an unmatched comfort level for the user. In addition, its design minimizes waste whilst at the same time maximizing adhesive usage.

Throughout the PowerCure project we maintained a strong focus on the key elements that make PowerCure the product you can hold in your hand today.

- **Focus on quality** – Swiss-engineered, assembled with reliable partners in Switzerland
- **Focus on the user** – system ergonomics and usability as key to achieving high user acceptance
- **Focus on performance** – versatility, from high speed to extended working time

KEY BENEFITS

Two-component

PERFORMANCE,
with the fastest through curing time

EASY TO USE

as a 1C system, with a short, ergonomic mixer

Cures

INDEPENDENT OF THE CLIMATE,
outperforms any other adhesive at low temperatures

LONG OPEN TIME

allows acceleration use without changes to work process

REDUCED WASTE

compared with any other booster or 2C system on the market, maximizes yield

COMPATIBLE

with a number of adhesive technologies including polyurethanes, silane modified polymers (SMP) and silicones

SIDE BY SIDE: PowerCure VERSUS EXISTING TECHNOLOGIES

PowerCure's revolutionary design combines the benefits of both one- and two-component adhesive systems. It delivers simple application and incredible reliability for all kinds of manual and mobile applications. The mixing ability of PowerCure opens up a broad field of new applications and allows it to be used with all kinds of adhesive technologies, including silane modified polymers (SMP), polyurethane, and silicones.

When Sika took up the challenge of redefining the accelerated adhesive system, we discovered that most two-component or accelerated systems fail because they are complex to use. From the very beginning, simplicity and user experience were key elements in developing PowerCure.

PowerCure VS.

ONE-COMPONENT ADHESIVE TECHNOLOGY (1C)

Most users are aware of the limitations that come with one-component technology, such as slow through curing and dependency upon climate. Until now, technologies introduced to overcome these limitations have not succeeded mainly due to complexity in handling or the need to invest in pump equipment.

PowerCure VS.

TWO-COMPONENT ADHESIVE TECHNOLOGY (2C)

Two-component adhesive systems for elastic bonding exist in various versions on the market. Typically these systems are either designed for high-volume applications out of drums or require special cartridge packaging which makes them expensive and complicated to use. Standard two-component products' curing reaction is demanding in terms of the dosing accuracy required in order to ensure that the final properties are not compromised. PowerCure adhesives are cured by moisture in the accelerator paste. This technology is much less demanding in terms of dosing accuracy, and adhesives will even reach final performance as specified without the accelerator.

PowerCure VS. BOOSTER

Accelerated or "boostered" adhesives and sealants have become more important in recent years, in particular in large-scale assembly processes. Sika was a pioneer of the booster technology. However, to benefit from the technology, investment in pumps was necessary. With PowerCure, Sika delivers production line performance even for smaller applications. PowerCure replaces the SikaBooster® Adapter and has taken the technology to an entirely new level of performance and user-friendliness. PowerCure adhesives can be accelerated without the time-consuming preheating step required by current booster adhesives. Additionally, the adhesive and accelerator packaging is self-opening, thereby cutting out two steps normally required before even starting application.

"It was impressive to be part of the steering team and see how the project evolved in this unique solution. In the technical department we tested the system with over more than 10,000 applications and it proved its reliability impressively. PowerCure is designed as a platform for adhesives and sealants of various chemistries and I am convinced it will become the most secure and flexible solution for accelerated process materials. It is like having the safety level of OEM equipment in a handy format."

MAURO MASOCH

HEAD CORPORATE TECHNICAL DEPARTMENT
SIKA SERVICES AG

ADHESIVE IN COMPARISON

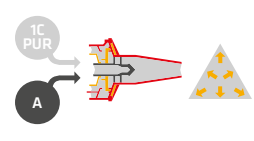
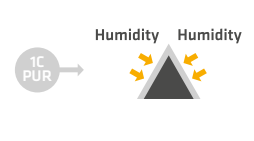
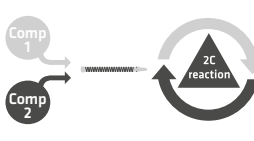
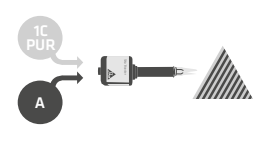
SYSTEM	PowerCure	1C adhesives	2C adhesives	Booster
ATTRIBUTES				
Curing agent	Water-based accelerator or air moisture	Atmospheric moisture	Reactive B-component	Water-based accelerator or air moisture
Mixing	Dynamic mixing → homogeneous mixture	NA	Static mixers & dynamic mixers available	Static mixing → inconsistent curing due to layers
Mixing ratio	50:1	NA	Various types available, from 1:1 to 10:1	2 % approximately
Dosing	Precise screw dosing	NA	Piston dosing	Driven by adhesive flow, dependent on adhesive viscosity and temperature
Preheating	Not required, works from -20°C to 50°C	NA	Typically not required	Cartridge approximately 1 hour at 80°C (not required for pump solution)
Curing typo	Homogeneous, curing from inside	From outside	Homogeneous, curing from inside	Curing through layers
Dosing accuracy	Required for curing speed	NA	Required for curing speed and final properties	Required for curing speed
Final strength/ Full cure	Reached within hours	Reached within 7 days approximately	Reached within hours	Reached within hours
Toolability	Toolable products possible, ask for advice on product selection	Toolable products possible, ask for advice on product selection	Toolable products possible	Not possible
Temperature dependency	Reaction speed is almost independent of temperature	High climate dependency	Reaction speed is highly dependent of temperature	Reaction speed is almost independent of temperature

BENEFITS AT A GLANCE

PowerCure VS. ONE-COMPONENT ADHESIVE TECHNOLOGY (1C)

- Simple and quick to use, like a one-component product
- Fastest through curing, final strength in hours, nearly regardless of temperature
- Portable and ergonomic dispenser, endorsed by field technicians

PowerCure VS. TWO-COMPONENT ADHESIVE TECHNOLOGY (2C)

- Best balanced performance, optimal open time and fastest curing speed
- Minimized non-hazardous waste, no product left in used packaging
- Robust technology, less demanding in terms of dosing accuracy than standard two-component systems
- Temperature-independent curing, fast curing in nearly all conditions

PowerCure VS. BOOSTER

- Ready to go, no preheating required
- Quick and easy use, once in the dispenser, unipack opens automatically
- Highest yield, maximizes available adhesive in reusable 600 ml packs
- Minimized waste, reduced packaging

THE HIGHEST PRECISION, IN YOUR HANDS

The PowerCure adhesive system delivers the precision and performance of the high-end pump systems found on manufacturers' production lines. It combines high flexibility, ergonomic and easy handling, and minimal waste in a clear and focused design. The use of a single, brushless motor mechanically couples extrusion, dosing and dynamic mixing, and allows users to control extrusion speed on the go without compromise. Providing the fastest curing adhesives at an unmatched comfort level for the user, PowerCure is the total solution for smaller sealing and bonding applications.

PowerCure DISPENSER

Single motor design: The PowerCure dispenser matches the precision of pump and dosing systems found on vehicle manufacturers' production lines. The use of a single, brushless motor mechanically couples extrusion, dosing and dynamic mixing and allows users to control extrusion speed on the go without compromise.

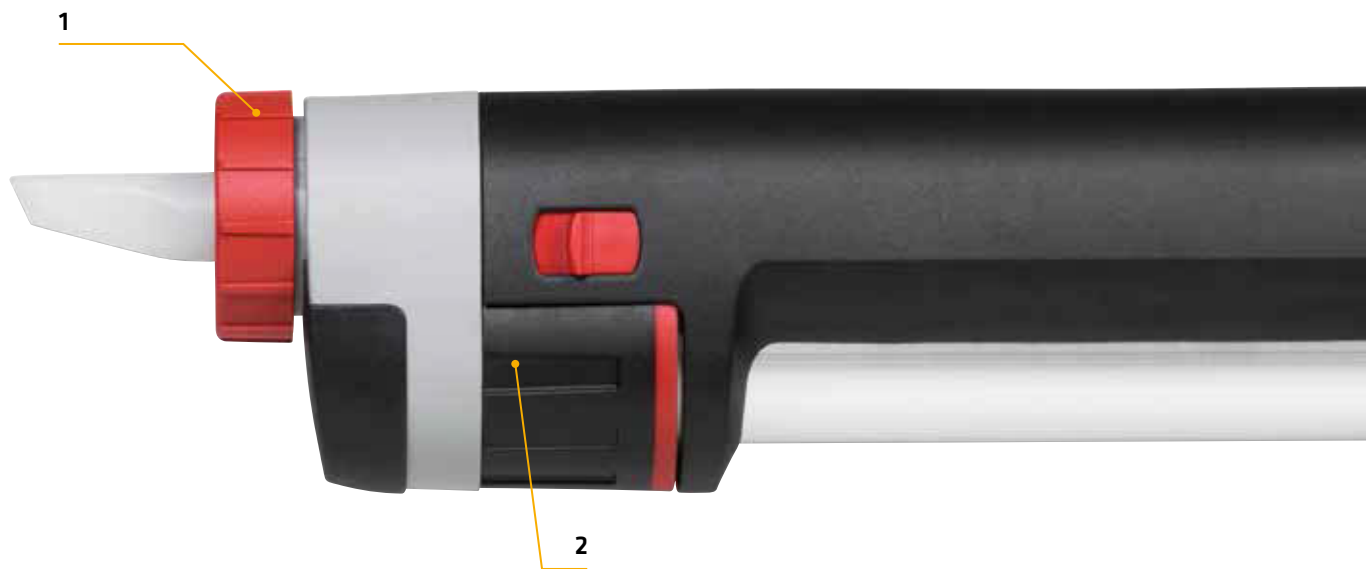

1

QUICK MIXER REPLACEMENT

The PowerCure mixer is designed to be mounted and unmounted in just a few steps, making the system quick and easy to use.

2

EASY ADHESIVE REFILL

Thanks to the unique bayonet closure, reloading the system with a new unipack is even faster than with ordinary one-component systems.

3

ERGONOMIC SOFT HANDLE

Not only is the handle made out of soft material, it is also in the right position to ideally balance the weight of the system.



"From the very beginning we analyzed working and handling procedures of users in the field. Every little step was questioned and constantly challenged. We aimed to make using PowerCure as simple as using a single component product. In many aspects it's even simpler and faster."

DAVID TOBLER
HEAD AUTOMOTIVE AFTERMARKET
SIKA SERVICES AG



3

4

LI-ION POWERED

Based on high-end Li-ion batteries to allow operation without cables and hoses. The battery provides enough power for multiple unipacks without recharging.

4

MAXIMIZING YIELD AND REDUCING WASTAGE

Sika bonding technologies increase the safety of end products and allow for greater freedom of design. Bonding joins different materials permanently, elastically and securely. Sika sealing products minimize the flow of gases and liquids between cavities and interstices as well as the dissemination and transfer of heat or cold. Immense flat roofs and sophisticated facades become durable and impervious to wind and rain, and resistant to temperature, age, and vibration. With the new PowerCure technology and accelerated adhesives, Sika continues its tradition of developing outstanding and innovative products. One of its major achievements is reducing waste by up to 60% compared with current two-component solutions, a clear testament to Sika's global commitment to sustainable products.

PowerCure PACKAGING

Based on the unipack: PowerCure packaging is based on the unipack, the most efficient packaging solution for windshield adhesives. The packaging is designed to minimize wastage and make mounting and replacement a breeze.

MINIMIZING WASTE

From the first stage of PowerCure's development, Sika began searching for the most effective packaging solution for accelerated adhesives. The SikaBooster® pack and standard two-component products were analyzed and the one-component unipack was taken as a benchmark. The resulting design of the PowerCure pack and mixer reduces packaging waste to a minimum. Additionally, Sika aimed to maximize the amount of adhesive available for application, in contrast to the booster and two-component systems analyzed. Last but not least, the system optimizes the overall working process for the technician by using the well-accepted unipack/sausage packaging mounted into a plastic shoulder along with the accelerator paste.

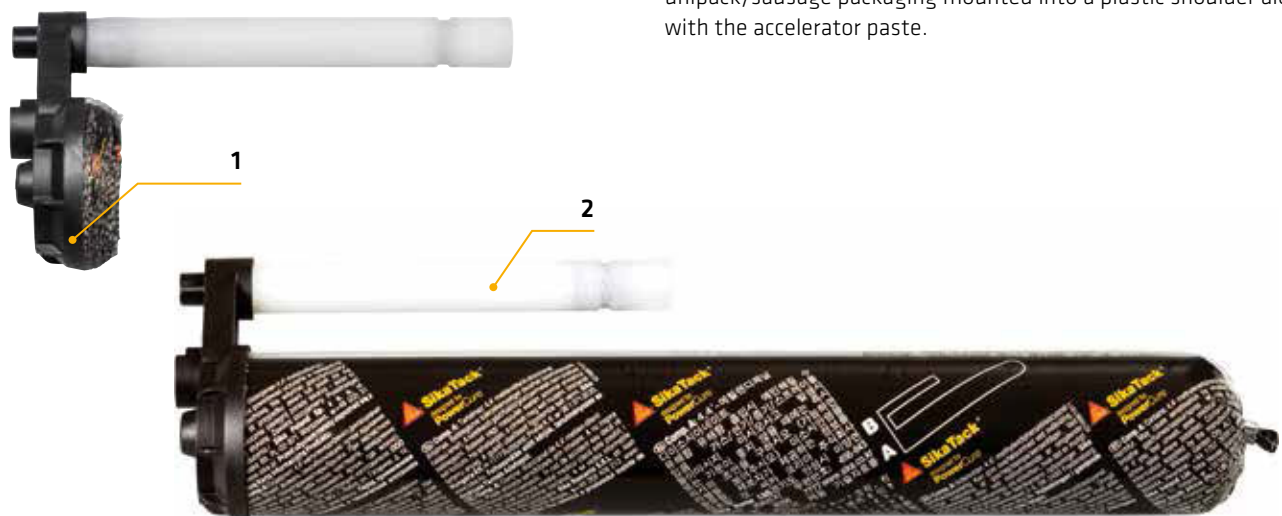

1

LOW WASTAGE

Using the unipack for the adhesive packaging minimizes wastage.

2

RELIABLE DOSING

The accelerator paste is dosed by a screw dosing mechanism which is known as one of the most precise dosing techniques.

PowerCure MIXER

Dynamic and efficient: The mixer is designed to fit an ordinary application nozzle. The specially shaped v-cut supports the application of the adhesive at a convenient angle to the glass and cuts material consumption by up to 8%.

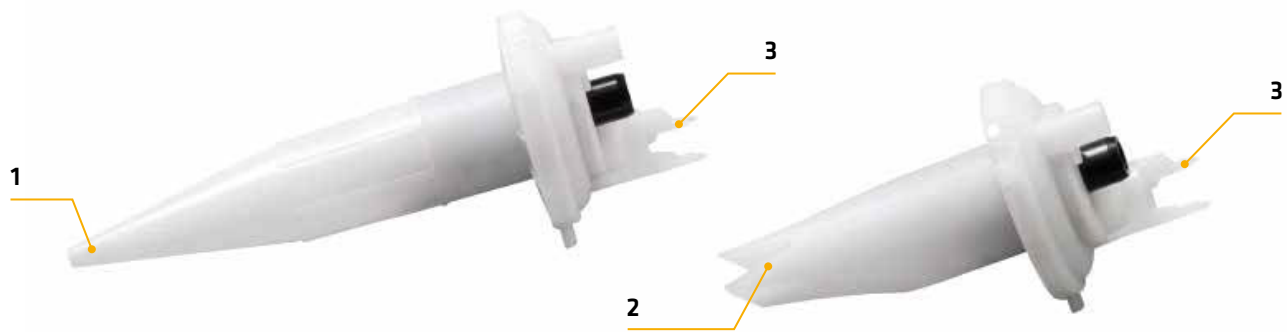

1

VERSATILE ROUND NOZZLE

The round nozzle is based on an adapter part which can be combined with different types of nozzles, providing maximum freedom in terms of selecting the right nozzle for each application.

2

IMPROVED V-CUT NOZZLE

The v-cut nozzle has been optimized to allow application at a different working angle and to reduce adhesive consumption by up to 8%.

3

SELF-OPENING MECHANISM

The self-opening mechanism is integrated into the mixer, ensuring that the adhesive is opened at exactly the right moment.

"PowerCure contains the most reliable dosing and mixing technique on the market, ensuring the performance is delivered in every application. PowerCure not only administers the fastest curing adhesives, it also permits long working time followed by fast strength build up – independent of the climate, location, or application speed."

ANDREAS HUFSCHMID

PROJECT MANAGER PowerCure
SIKA SERVICES AG

BENEFITS AT A GLANCE

- Highest yield – maximized adhesive available for installation
- Minimized non-hazardous waste – no product left in used packaging
- 8% higher yield due to the special nozzle design



PowerCure ADVANCED ADHESIVES FOR REPAIR APPLICATIONS

Independent of climate, PowerCure adhesives cure within minutes to the level specified by vehicle manufacturers, thereby rapidly restoring car, truck, bus, coach or even rail body structures to their original strength. The application possibilities are unlimited, as the system has been developed to work in the harsh outdoor conditions typical of the vehicle glass repair and replacement industry.

With its flexible handling and battery-driven mobility, the PowerCure system delivers unprecedented performance for repair applications not only in the field of auto glass and commercial vehicle glass replacement but also in facade repairs and other applications that require a fast turnaround time.

Its ergonomic handling in combination with advanced adhesives makes the PowerCure system unmatched in terms of user comfort and bonding performance. Starting with day one of its development, the special needs of auto glass technicians were taken into account, the result being that using PowerCure feels like working with a one-component product, while at the same time delivering the performance of a two-component material. Taking control over the entire system gave us the opportunity to deliver enough force to allow extrusion even below 0°C without the need for preheating.

BENEFITS AT A GLANCE

- Adhesives reach strength level specified by vehicle manufacturers in less than 1 hour
- Toolable two-in-one product for sealing and bonding in commercial vehicle glass replacement
- Flexible handling, no power cables, hoses or compressors
- Fast curing, nearly independent of curing conditions

AUTO GLASS REPLACEMENT

As one of the key products in the auto glass industry, SikaTack® ELITE delivers a new level of performance and safety. SikaTack® ELITE achieves a Safe Drive Away Time (SDAT) of as little as 30 minutes and reinforces car bodies to the level of a new vehicle within just one hour. Being committed to a high level of safety, Sika employed a new, even stricter crash-test standard to determine the SDAT of SikaTack® ELITE.



With SikaTack® ELITE, a car can be lifted by its windshield just 60 minutes after installation.



PowerCure ADHESIVES FOR SMALL SCALE ASSEMBLY BONDING

The PowerCure system provides the precision and performance of a high-end pump system for smaller sealing and bonding applications. PowerCure is the ideal solution for areas that are difficult to reach with a pump, and the ideal work companion for assembly bonding jobs requiring fast curing speed.

The PowerCure system allows line applications where less consumption is required and pump equipment is not financially justified. The system makes applications in areas that are difficult to reach with a pump system possible, such as where space is limited or in areas not easily reached without lifting devices. And since maneuvering with heavy application guns and hoses can be burdensome, the flexibility and ergonomic advantages provided by the PowerCure system cannot be underestimated. With PowerCure, Sika aimed to eliminate the constrictions associated with current booster systems applied with pump equipment. The result is a system that combines simplicity, flexibility and ergonomics for a low financial investment.

BENEFITS AT A GLANCE

- Fast application, short cycle time
- Low investment
- Reduced waste
- Flexible handling, makes hard-to-reach jobs manageable
- Fast curing, nearly independent of curing conditions

TRANSPORTATION

The PowerCure system is suitable for all markets associated with transportation. The possibilities are many, and include assembly bonding applications in the bus, truck, rail, and caravan sectors and in other special vehicles. Depending on the task, there are scores of potential applications, such as direct glazing, open joint sealing, and assembly bonding (panels, flaps, roofs, floors, etc.), as well as fast repairs at the end of a production line.

With Sikaflex®-271 PowerCure and Sikaflex®-268 PowerCure, a new level of performance and safety has been achieved. Adhesive strength buildup is rapid thanks to the incorporation of dynamic mixing and special chemistry. Sika's PowerCure products offer a whole new dimension in terms of faster, safer and more cost efficient commercial vehicle production.

FACADE AND WINDOWS

The PowerCure system makes fast and economic small-scale facade and window assembly possible in cases where pump equipment for two-component adhesives is not financially justified or where work and storage space is limited. It capitalizes on the benefits of fast curing two-component adhesives, which have short cycle and storage times for curing, and those of one-component adhesives, which offer less waste in a stop-and-go application. Another invaluable feature is the increased joint bite the PowerCure system offers compared to one-component adhesives. PowerCure removes the limitations associated with current gun-applied one-component systems, while at the same time offering a versatile and ergonomic system for a low financial investment.



PowerCure ADHESIVES FOR MORE FLEXIBILITY ON-SITE

The PowerCure system is highly mobile and reliable for on-site jobs. Because of its unique resilience to environmental conditions, PowerCure is ideally suited for bigger on-site applications where ease of use is a must.

Nowadays, many on-site applications are done using one-component structural silicone. The biggest advantage of this is its ease of handling. The downside is that curing speed is heavily dependent upon climatic conditions. Extreme temperatures restrict application time and logistics need to be planned according to weather forecasts. A two-component silicone system eliminates climatic constraints, but is hindered by issues with the equipment required and by costly cartridges. In a revolutionary leap, the "boostered" one-component silicone used in Sika's PowerCure system combines the benefits of both one- and two-component systems by merging a climate-independent and quick-curing adhesive with the utmost ease of manual application.

BENEFITS AT A GLANCE

- Low investment
- Reduced waste
- Flexible handling, no power cables, hoses or compressors
- Fast curing, nearly independent of curing conditions

FACADE AND WINDOW REPAIR

The PowerCure system provides straightforward on-site application for glass replacement jobs. With its unmatched ergonomic design, it handles like a one-component device. And since it cures like a two-component adhesive, conditions such as air humidity and lower temperatures have almost no influence over joint bite. Moreover, the battery-driven PowerCure runs without the need for cables or a compressor, meaning there is almost no limitation on its use, including working in harsh outdoor conditions typical for facade repair.

SOLAR

Frameless photovoltaic modules on roofs and ground mount racking systems are usually bonded with a one-component silicone applied along with tape pads as distance providers and pre-fixation support. With the new PowerCure technology this dependency is eliminated, as it relies on the simplicity of a one-component silicone coupled with the fast curing and resilience of a two-component adhesive. Consequently, photovoltaic module bonding jobs can be handled more easily and more independently than ever before.



PowerCure ADHESIVES FOR RAPID JOINT SEALING

PowerCure is Sika's new platform for accelerated adhesive and sealant systems. The dynamic PowerCure mixer ensures homogenization of the two components, yielding a toolable sealant that is fully cured within hours. The result is an ideal solution for large sealing joints in various applications.

Because joint sealants make up only a small portion of the monetary value of a project, they are often considered an unimportant detail. However, joint sealants play a major role in keeping an object air- and watertight and thus prevent potential damage which could result in unforeseeable costs. In particular large joints as applied in rail manufacturing can require a long curing time if they are sealed using one-component products. PowerCure based sealants offer new opportunities due to their fast curing reaction combined with long working time. And, as PowerCure creates a homogeneous mixture, accelerated sealing joints remain toolable for a long time.

BENEFITS AT A GLANCE

- Long working time but fast curing
- Toolable thanks to homogeneous mixture
- Low investment
- Easy application, makes hard-to-reach jobs manageable
- Fast curing, nearly independent of curing conditions

TRANSPORTATION

Rail vehicle manufacturers face complex and varied challenges in the design and assembly of roof and mask systems for modern rail vehicles. High speeds, harsh environments and aerodynamic structural stresses within the vehicle need to be taken into consideration when selecting the correct sealant solution. Thanks to the incorporation of dynamic mixing and special chemistry, PowerCure's sealants are cured quickly whatever the thickness of the joint while remaining toolable for quite a long time.

FACADE INSTALLATION

Fast curing sealants provide added value in facade installations exposed to extreme conditions. Silicone sealants powered by PowerCure will fully cure quickly in cold and hot climates, whatever the thickness of the joint.



"Sika's vision of making PowerCure as easy to use as a one-component system was a challenging goal. The open work environment between the three partners not only helped identify the smartest solutions but also the best one in the eyes of the user. Sika's early customer market evaluations and the flexibility gained by going the extra mile helped keep complexity down and resulted in the perfect solution for the users."

CHRISTIAN SCHULTHEISS
PROJECT MANAGER AND ENGINEER
CEKAtec AG, WATTWIL, SWITZERLAND

SWISS-ENGINEERED AND ASSEMBLED WITH RELIABLE PARTNERS

PowerCure is a Swiss-developed product realized by Sika in collaboration with Sulzer Mixpac and CEKAtec. Sika took care to find the best partners when developing this breakthrough innovation. Both partner companies are recognized as technology leaders in their respective fields and contributed their specific knowledge to the advancement of PowerCure. This unique synergy played a key role in making PowerCure a reality.



At CEKAtec AG, every PowerCure dispenser is tested in a simulated application before delivery.

With CEKAtec, an expert in the development and manufacturing of battery-driven power tools, and Sulzer Mixpac, a market leader in packaging and mixing, Sika united the know-how of three leading Swiss companies to create a remarkable product. Throughout the project we were able to create an open work environment pursuing a single joint target. This allowed us to search for the best solution in the eyes of the user and reliability without being restricted to just the adhesive, the mixer or the dispenser. It allowed us to develop solutions at the part of the system where it could have the greatest impact.

SIKA

Founded in Switzerland by visionary inventor Kaspar Winkler in 1910, Sika embodies the Swiss notion of quality and sustainability. Since then, it has developed into a successful global company positioned at the forefront of development and production of systems and products for bonding, sealing, damping, reinforcing and protecting in the building sector and the motor vehicle industry. Not only is Sika a world market pioneer in construction chemicals; it is also the leading adhesive producer for industrial markets, having over 160 factories worldwide. With its strong focus on innovation, Sika secured 70 patents in 2014 alone.

SULZER MIXPAC

Sulzer Mixpac is a Business Unit of the Sulzer Group headquartered in Switzerland, with subsidiaries in the USA, UK, Denmark and China to ensure the best possible customer care on a global scale. With more than 500 employees, the company is recognized worldwide as being the technology leader for dispensing technology especially in the area of mixing, metering and dispensing of two-component materials.

CEKAtec AG

CEKAtec is a medium-sized Swiss company based in Toggenburg and has approximately 70 employees. In addition to offering its major international customers innovative engineering (Swiss Technology Award 2007), CEKAtec is the market leader in the customized development, testing and manufacturing of electro-mechanical equipment and energy systems for high value "SWISS MADE" products.

PUBLISHED BY
Sika Services AG, Industry, Tueffenwies 16, CH-8048 Zurich
Tel. +41 58 436 40 40, industry@ch.sika.com, www.sika.com/industry

CONCEPT, DESIGN, TEXT AND REALIZATION
fachwerk Kommunikation AG, www.fachwerkag.ch

PHOTOGRAPHY
Justin Hession, www.justinhession.ch

GLOBAL BUT LOCAL PARTNERSHIP



FOR MORE INFORMATION:



www.sika.com/powercure

WHO WE ARE

Sika is a specialty chemicals company with a leading position in the development and production of systems and products for bonding, sealing, damping, reinforcing and protecting in the building sector and the motor vehicle industry. Sika has subsidiaries in 90 countries around the world and manufactures in over 160 factories. Its more than 17,000 employees generated annual sales of CHF 5,6 billion in 2014.

Our most current General Sales Conditions apply.
Please consult the Data Sheet prior to any use and processing.



SIKA SERVICES AG
Tueffenwies 16
CH-8048 Zurich
Switzerland

Contact
Phone +41 58 436 40 40
Fax +41 58 436 55 30
www.sika.com/industry

BUILDING TRUST

