

Safewaze Full Body Harness



WARNING



This product is part of a personal fall arrest, work positioning, or rescue system. The manufacturer's instructions must be provided to users of this equipment. The user must follow the manufacturer's instructions for each component of the system. The user must read and understand these instructions before using this equipment. Manufacturer's instructions must be followed for proper use and maintenance of this equipment. Alterations to this product, misuse of this product, or failure to follow instructions may result in serious injury or death.



IMPORTANT

Questions regarding the use, care, or suitability of this equipment for your application? Contact Safewaze.



IMPORTANT

Record identification information before using this product. Identification information may be found on the equipment label (See Figure 22). This information should be recorded in the "Inspection Form" located at the back of this manual (p 20).

ANSI Z359.11-2021

OSHA 1910.66, OSHA 1926.502

This manual is intended to meet the manufacturer's instructions as required by ANSI Z359.11 and should be used as part of an employee training program as required by OSHA.

Table of Contents

1.0 INTRODUCTION	1
2.0 APPLICATION	1
3.0 APPLICABLE SAFETY STANDARDS	1
4.0 WORKER CLASSIFICATIONS	1
5.0 PURPOSE	1
6.0 LIMITATIONS & REQUIREMENTS	2-4
7.0 COMPATIBILITY OF COMPONENTS	4
8.0 COMPATIBILITY OF CONNECTORS	4
9.0 MAKING CONNECTIONS	5
10.0 BUCKLE/ADJUSTER OPERATION	5-6
11.0 APPLICATION LIMITS	7
12.0 RESTRICTIONS	7
13.0 FBH PRE-USE INSPECTION	7
14.0 HARNESS SIZING AND FITMENT	8
15.0 DONNING AND ADJUSTING THE HARNESS	9
16.0 BWB INSTALLATION AND USE	10-13
17.0 USE	13-16
18.0 MAINTENANCE, CLEANING & STORAGE	17
19.0 INSPECTION	17-18
20.0 LABELING	19
21.0 INSPECTION FORM	20

User Information

Date of First Use: _____

Serial#: _____

Trainer: _____

User: _____



These instructions must be provided to any person utilizing this equipment. The worker must read and understand the manufacturer's instructions for this, and all other components of the complete Fall Protection System. It is expected that all personnel be fully trained in the safe installation and use of this equipment. These instructions must be followed for the proper use, maintenance, and inspection of this equipment. These instructions must be kept and made available to worker's at all times. Any alteration, misuse, or use of this equipment outside the scope of the manufacturer's instructions, may result in serious injury or death. A comprehensive Fall Protection Plan must be kept on file and available to all employees at all times.

Inspect all components of this system prior to each use and at least annually. Inspect in accordance with the user instructions. If this equipment is exposed to the forces of a Fall Arrest or Impact Force, the equipment must be removed from service and inspected by a Competent Person prior to being used again.

This product is part of a complete fall protection system. A PFAS is typically composed of a Full Body Harness, Anchorage, and a Connecting Device. Connecting Devices used with Safewaze Full Body Harnesses are Energy Absorbing Lanyards (EAL's) or a Self Retracting Lifeline (SRL). The connection point to the FBH for use of a Safewaze Vertical Lifeline (VLL) is the Sternal (Front) D-ring.

Personnel must always maintain 3 points of contact during climbing operations. If utilizing components from different manufacturers, ensure that all components are compatible and meet all applicable standards, codes, and requirements. Before using this equipment, consult with a Competent and/or Qualified Person.

Consult your doctor if there is reason to doubt your fitness to safely absorb the shock from a fall arrest. Age and fitness seriously affect a worker's ability to withstand falls. Pregnant women or minors must not use this equipment. Failure to heed this warning may result in serious injury or death.

Never exceed the maximum allowable capacity of your fall protection equipment. Never exceed the maximum free fall distance of your fall protection equipment.

Do not use this system or any other part of a PFAS that fails pre-use or other scheduled inspections. For any questions or concerns regarding the use of this equipment for an application not specified in this manual, contact Safewaze technical support.

Additional precautions should be used when working in environments of high heat, electrical hazards, chemical hazards, explosive or combustible chemicals, toxic materials, sharp edges, or where equipment used above could topple onto a user below or their fall protection equipment.

Use of a body belt for fall protection applications is not permitted. Only use an approved Full Body Harness.

Make considerations for eliminating or minimizing all swing fall hazards. Swing falls occur when the anchor is not directly above the location where a fall occurs. Always work as close to in line with the anchor point as possible. Swing falls significantly increase the likelihood of serious injury or death in the event of a fall.

Contact Safewaze if you have questions regarding compatibility of this equipment that are not covered in this manual. Do not alter or misuse this equipment. Some subsystem components could affect the performance and the operation of this equipment. Do not anchor this product to moving machinery, or hazards that have chemical, electrical or gaseous characteristics. Failure to comply with this warning could result in serious injury or death.

Do not throw away these instructions!
Read and understand these instructions before using equipment!



Per ANSI Z359.11-2021:

It is essential that the users of this type of equipment receive proper training and instruction including detailed procedures for the safe use of such equipment in their work application. ANSI/ASSP Z359.2, *Minimum Requirements for a Comprehensive Managed Fall Protection Program*, establishes guidelines and requirements for an employer's managed fall protection program including policies, duties and training; fall protection procedures; eliminating and controlling fall hazards; rescue procedures; incident investigations; and evaluating program effectiveness.

Correct fit of a full body harness (FBH) is essential to proper performance. Users must be trained to select the size and maintain the fit of their FBH.

Users must follow manufacturer's instructions for proper fit and sizing, paying particular attention to ensure that buckles are connected and aligned correctly, leg straps and shoulder straps are kept snug at all times, chest straps are located in the middle chest area and leg straps are positioned and snug to avoid contact with the genitalia should a fall occur.

FBHs which meet ANSI/ASSP Z359.11 are intended to be used with other components of a personal fall arrest system that limit maximum arrest forces to 1800 pounds (8kN) or less.

Suspension intolerance, also called suspension trauma or orthostatic intolerance, is a serious condition that can be controlled with good harness design, prompt rescue and post fall suspension relief devices. A conscious user may deploy a suspension relief device allowing the user to remove tension from around the legs, freeing blood flow, which can delay the onset of suspension intolerance. An attachment element extender is not intended to be attached directly to an anchorage or anchorage connector for fall arrest. An energy absorber must be used to limit maximum arrest forces to 1800 pounds (8 kN). The length of the attachment element extender may affect free fall distances and free fall clearance calculations.

FBH stretch, the amount the FBH component of a personal fall arrest system will stretch and deform during a fall, can contribute to the overall elongation of the system in stopping a fall. It is important to include the increase in fall distance created by FBH stretch, as well as the FBH connector length, the settling of the user's body in the FBH and all other contributing factors when calculating total clearance required for a particular fall arrest system.

When not in use, unused lanyard legs that are still attached to a FBH D-ring should not be attached to a work positioning element or any other structural element on the FBH unless deemed acceptable by the competent person and manufacturer of the lanyard. This is especially important when using some types of "Y" style lanyards, as some load may be transmitted to the user through the unused lanyard leg if it is not able to release from the harness. The lanyard parking attachment is generally located in the sternal area to help reduce tripping and entanglement hazards.

Loose ends of straps can get caught in machinery or cause accidental disengagement of an adjuster. All FBH shall include keepers or other components which serve to control the loose ends of straps.

Due to the nature of soft loop connections, it is recommended that soft loop attachments only be used to connect with other soft loops or carabiners. Snaphooks should not be used unless approved for the application by the manufacturer.

The following is additional information concerning the location and use of various attachments that may be provided on this FBH:

Dorsal - The dorsal attachment element shall be used as the primary fall arrest attachment unless the application allows the use of an alternate attachment. The dorsal attachment may also be used for travel restraint or rescue. When supported by the dorsal attachment during a fall, the design of the FBH shall direct load through the shoulder straps supporting the user and around the thighs. Supporting the user, post fall, by the dorsal attachment will result in an upright body position with a slight lean to the front with some slight pressure to the lower chest. Considerations should be made when choosing a sliding versus fixed dorsal attachment element. Sliding dorsal attachments are generally easier to adjust to user sizes, and allow a more vertical rest position post fall, but can increase FBH stretch.

Sternal - The sternal attachment may be used as an alternative fall arrest attachment in applications where the dorsal attachment is determined to be inappropriate by a competent person and where there is no chance to fall in a direction other than feet first. Accepted practical uses for sternal attachment include, but are not limited to, ladder climbing with a guided type fall arrester, ladder climbing with an overhead self-retracting lifeline for fall arrest, work positioning and rope access. The sternal attachment may also be used for travel restraint or rescue.

When supported by the sternal attachment during a fall, the design of the FBH shall direct load through the shoulder straps supporting the user and around the thighs. Supporting the user, post fall, by the sternal attachment will result in roughly a sitting or cradled body position with weight concentrated on the thighs, buttocks, and lower back. Supporting the user during work positioning by this sternal attachment will result in an approximate upright body position.

If the sternal attachment is used for fall arrest, the competent person evaluating the application should take measures to ensure that a fall can occur feet first. This may include limiting the allowable free fall distance. It may be possible for a sternal attachment incorporated into an adjustable style chest strap to cause the chest strap to slide up and possibly choke the user during a fall, extraction, suspension, etc. The competent person should consider FBH models with a fixed sternal attachment for these applications.

Shoulder - The shoulder attachment elements shall be used as a pair and are an acceptable attachment for rescue and entry/retrieval. The shoulder attachment elements shall not be used for fall arrest. It is recommended that the shoulder attachment elements be used in conjunction with a yoke which incorporates a spreader element to keep the FBH shoulder straps separate.

Frontal - The frontal attachment serves as a ladder climbing connection for guided type fall arresters where there is no chance to fall in a direction other than feet first or may be used for work positioning. Supporting the user, post fall or during work positioning, by the frontal attachment will result in a sitting body position with the upper torso upright with weight concentrated on the thighs and buttocks. When supported by the frontal attachment the design of the FBH shall direct load directly around the thighs and under the buttocks by means of the sub-pelvic strap.

If the frontal attachment is used for fall arrest, the competent person evaluating the application should take measures to ensure that a fall can only occur feet first. This may include limiting the allowable free fall distance.

Hip - The hip attachment elements shall be used as a pair and shall be used solely for work positioning. The hip attachment elements shall not be used for fall arrest. Hip attachments are often used for work positioning by arborists, utility workers climbing poles and construction workers tying rebar and climbing on form walls. Users are cautioned against using the hip attachment elements (or any other rigid point on the FBH) to store the unused end of a fall arrest lanyard as this may cause a tripping hazard or, in the case of multiple leg lanyards, could cause adverse loading to the FBH and the wearer through the unused portion of the lanyard.

Waist, Rear - The waist, rear attachment shall be used solely for travel restraint. The waist, rear attachment element shall not be used for fall arrest. Under no circumstances is it acceptable to use the waist, rear attachment for purposes other than travel restraint. The waist, rear attachment shall only be subjected to minimal loading through the waist of the user and shall never be used to support the full weight of the user.

Suspension Seat - The suspension seat attachment elements shall be used as a pair and shall be used solely for work positioning. The suspension seat attachment elements shall not be used for fall arrest. Suspension seat attachments are often used for prolonged work activities where the user is suspended allowing the user to sit on the suspension seat formed between the two attachment elements. An example of this use would be window washers on large buildings.

FIGURE 1 - APPROVED D-RING APPLICATIONS

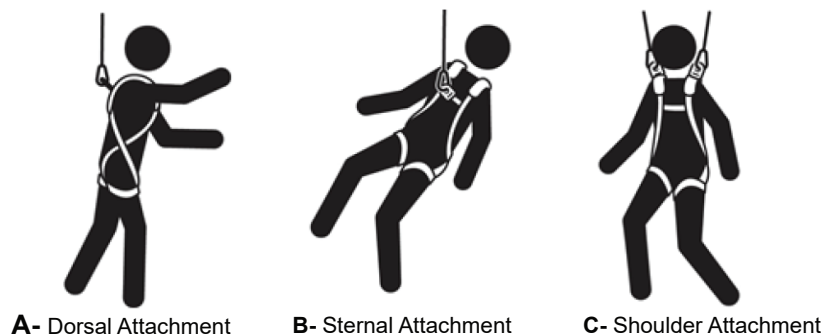



D- Frontal Attachment



E- Hip Attachment



F- Waist, Rear Attachment

Application	Harness Attachment Location
Fall Arrest	Dorsal, Sternal, Frontal
Restraint	Dorsal, Sternal, Frontal, Hip, Rear
Work Positioning	Frontal, Hip
Rescue	Dorsal, Sternal, Frontal, Shoulder
Controlled Descent	Dorsal, Sternal, Frontal
Climbing	Dorsal, Sternal

USER INSPECTION, MAINTENANCE AND STORAGE OF EQUIPMENT

Users of personal fall arrest systems shall at a minimum, comply with all manufacturer instructions regarding the inspection, maintenance and storage of the equipment. The user's organization shall retain the manufacturer's instructions and make them readily available to all users. See ANSI Z359.2, *Minimum Requirements for a Comprehensive Managed Fall Protection Program*, regarding user inspection, maintenance and storage of equipment.

- In addition to the inspection requirements set forth in the manufacturer's instructions, the equipment shall be inspected by the user before each use and additionally by a competent person, other than the user, at interval of no more than one year for:
 - Absence or illegibility of markings.
 - Absence of any elements affecting the equipment form, fit or function.
 - Evidence of defects in, or damage to, hardware elements including cracks, sharp edges, deformation, corrosion, chemical attack, excessive soiling, abrasion, alteration, needed or excessive lubrication, excessive aging and excessive wear.
- Inspection criteria for the equipment shall be set by the user's organization. Such criteria for the equipment shall equal or exceed the criteria established by this standard or the manufacturer's instructions, whichever is greater.
- When inspection reveals defects in, damage to, or inadequate maintenance of equipment, the equipment shall be permanently removed from service or undergo adequate corrective maintenance by the original equipment manufacturer or their designate before return to service.

MAINTENANCE AND STORAGE

- Maintenance and storage of equipment shall be conducted by the user's organization in accordance with the manufacturer's instructions. Unique issues, which may arise due to conditions of use, shall be addressed with the manufacturer.
- Equipment, which is in need of, or scheduled for, maintenance shall be tagged as unusable and removed from service.
- Equipment shall be stored in a manner as to preclude damage from environmental factors such as temperature, light, UV, excessive moisture, oil, chemicals and their vapors or other degrading elements.

1.0 INTRODUCTION

Thank you for purchasing a Safewaze Full Body Harness (FBH). This manual must be read and understood in its entirety, and used as part of an employee training program as required by OSHA or any applicable state agency. This manual and any other instructional material must be available to the user of the equipment. The user must understand how to safely and effectively use their full body harness, and all fall protection equipment used in conjunction with the full body harness.

2.0 APPLICATION

The Safewaze Full Body Harness (FBH) is the bodywear component of a Personal Fall Arrest System (PFAS). Safewaze Full Body Harnesses are offered in a variety of configurations to ensure that the user can work safely and comfortably in any work environment. These instructions will cover the proper donning and use of the FBH, as well as the proper connection of components and devices to the various connection points on the harness. The FBH must be properly fitted to the user. The Safewaze FBH is part of a complete PFAS that requires a properly rated anchorage and connector, that in conjunction with an appropriate connecting device, meets the fall protection requirement.

3.0 APPLICABLE SAFETY STANDARDS

When used according to instructions, harnesses included in this manual meet ANSI Z359.11-2021 and OSHA regulations for fall protection. Applicable standards and regulations depend on the type of work being done, and may include state-specific regulations. Refer to local, state, and federal (OSHA) requirements for additional information concerning the governing of occupational safety regarding Personal Fall Arrest Systems (PFAS).

4.0 WORKER CLASSIFICATIONS

Understand the definitions of those who work in proximity of or may be exposed to fall hazards.

Qualified Person: “Qualified Person” means one who, by possession of a recognized degree, certificate, or professional standing, or who by extensive knowledge, training, and experience, has successfully demonstrated his ability to solve or resolve problems relating to the subject matter, the work, or the project.

Competent Person: “Competent Person” means one who is capable of identifying existing and predictable hazards in the surroundings or working conditions which are unsanitary, hazardous, or dangerous to employees, and who has authorization to take prompt corrective measures to eliminate them.

Authorized Person: “Authorized Person” means a person approved or assigned by the employer to perform a specific type of duty or duties or to be at a specific location or locations at the job site.

It is the responsibility of a Qualified or Competent person to supervise the job site and ensure safety regulations are complied with.

5.0 PURPOSE

Purpose: The Safewaze series of full body harnesses are designed to be used as part of a Personal Fall Arrest System (PFAS).

- A competent person shall train users on this equipment in accordance with OSHA and ANSI.
- Never exceed a free fall distance of 6 ft. A free fall of more than 6 ft could cause excessive arrest forces that could result in serious injury or death.
- Safewaze harnesses have a maximum capacity of:
ANSI 310 lbs (140.6 kg) including tools, clothing, etc..., **OSHA** up to 420 lbs. (190.51 kg) including tools, clothing, etc...
- Anchorages for attachment of Safewaze full body harnesses shall support a minimum of 5,000 lbs or be designed with a safety factor of two by a Qualified Person.

- All Safewaze full body harnesses must IMMEDIATELY be removed from service if subjected to fall arrest forces.
- Safewaze full body harnesses shall be inspected by the end user prior to each usage and by a Competent Person other than the user at least annually. These annual inspections shall be documented.

6.0 LIMITATIONS & REQUIREMENTS

When installing or using this equipment always refer to the following requirements and limitations:

6.1 CAPACITY

Safewaze Full Body Harnesses are designed for the following weight capacities (Maximum capacities include clothing, tools, and equipment):

ANSI Z359: 130-310 lbs max
OSHA: Up to 420 lbs max

6.2 ANCHORAGE

Anchorage selected for fall arrest systems shall have a strength capable of sustaining static loads applied in the directions permitted by the system of at least:

1. 5,000 lbs. (22.2 kN) for non-certified anchorages, or
2. Two times the maximum arresting force for certified anchorages.

When more than one fall arrest system is attached to an anchorage, the strengths set forth in (1) and (2) above shall be multiplied by the number of systems attached to the anchorage.

From OSHA 1926.502 and 1910.66

Anchorage used for attachment of personal fall arrest systems shall be independent of any anchorage being used to support or suspend platforms, and capable of supporting at least 5,000 lbs (22.2 kN) per user attached, or be designed, installed, and used as part of a complete personal fall arrest systems which maintains a safety factor of at least two, and is under the supervision of a qualified person.

6.3 INSPECTION FREQUENCY

Either the Authorized Person (User), or the Rescuer must inspect this equipment before each use. Annual inspections must be completed by a Competent Person other than the user. Results must be documented.

6.4 RESCUE PLAN

When using this equipment, employers must create a rescue plan, and provide the means to implement the plan. This plan must be communicated to equipment users, authorized persons, and rescuers. Rescue operations require specialized equipment beyond the scope of this manual. See ANSI Z359.4-2013 for specific rescue information.



NOTE: Special rescue measures may be required for a fall over an edge.

6.5 FREE FALL

In order to ensure reduced fall distances, always attempt to anchor the connecting device directly overhead. Overhead anchoring will limit free fall distance to a minimum. Be aware of workers sharing the workspace to avoid becoming tangled with another worker. Steer clear of objects that could fall and impact a lifeline. The lifeline should never pass under the user's arms or legs. A lifeline should never be knotted, clamped, or be otherwise modified.

6.6 BODY SUPPORT

A Personal Fall Arrest System (PFAS) must utilize a Full Body Harness. Refer to Faigure one of this manual for specific FBH D-ring approved applications

6.7 FALL CLEARANCE

It is important to make sure that adequate clearance is available. Free Fall, Maximum Arrest Distance, Height of Worker, and current clearance above the next fall hazard must all be considered in the Fall Clearance calculation.

6.8 DETERMINE REQUIRED FALL CLEARANCE

Determining fall clearance is critical in understanding the correct connecting device to use. The lower the clearance height, the less options available to connect to the anchor point with. To Determine Fall Clearance several factors must be considered:

Length of Anchorage connector (LA)

Length of Connecting device (LC)

Maximum Arrest Distance of connecting device (MAD)

Height of Worker (HW)

Safety Factor (SF) - (Includes harness stretch, typically 2')

Distance from Anchor Point to next closest obstruction (DAP)

Using the above information Fall Clearance (FC) can be determined with the following formula

$$FC \text{ (from anchor point)} = LA + LC + MAD + HW + SF$$

Fall Clearance: There must be sufficient clearance below the anchorage connector to arrest a fall before the user strikes the ground or an obstruction. When calculating fall clearance, account for a MINIMUM 2' safety factor, deceleration distance, user height, length of lanyard/SRL, and all other applicable factors. (See Figure 2)

FIGURE 2 - DETERMINE REQUIRED FALL CLEARANCE

For all applications: worker weight capacity range (including all clothing, tools, and equipment) is 130-310 lbs. per ANSI Z359.11-2021. Weight capacity per OSHA is up to 420 lbs.

***Diagram shown is an example fall clearance calculation ONLY.

Fall Clearance Diagram

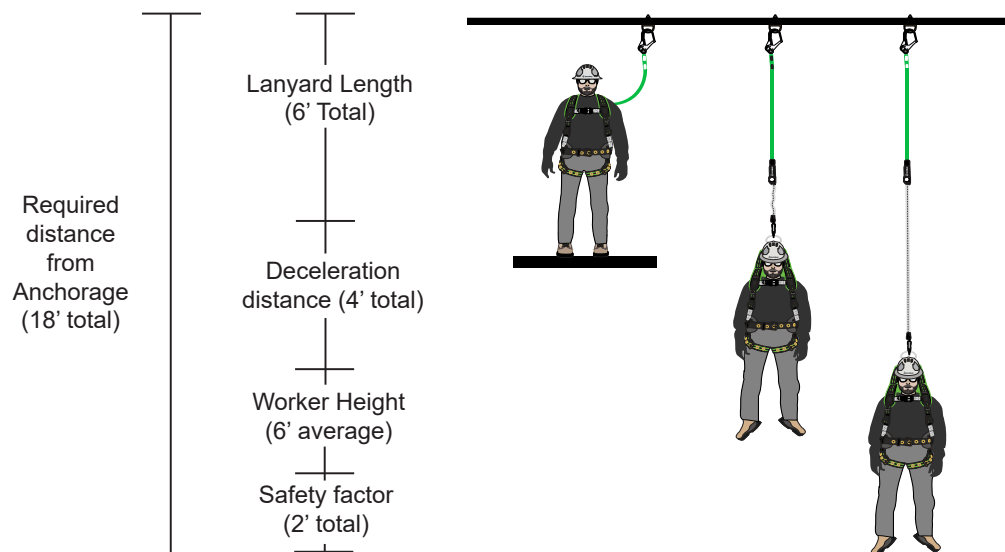

6.9 SWING FALLS

An anchorage point located in a position that is not directly over the user's fall location results in a swing fall (See Figure 3). Swing falls may result in the user striking an object with enough force to cause serious injury. Greater clearance is needed to ensure safety during a swing fall as vertical fall distance will be greater than a fall originating directly below the anchorage point.

FIGURE 3 - SWING FALLS

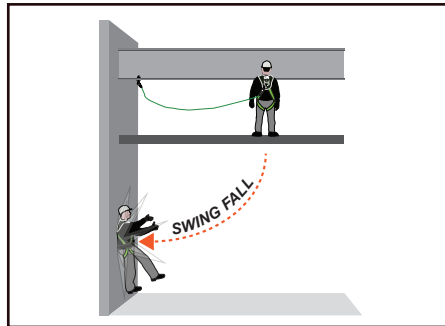

7.0 COMPATIBILITY OF COMPONENTS

Unless otherwise noted, Safewaze equipment is designed for use with Safewaze approved components and subsystems only. Substitutions or replacements made with non approved components or subsystems may jeopardize compatibility of equipment and may affect safety and reliability of the complete system.



IMPORTANT: Read and follow manufacturer's instructions for associated components and subsystems in your personal fall arrest system.

8.0 COMPATIBILITY OF CONNECTORS

Connectors are compatible with connecting elements when they have been designed to work together in such a way that their sizes and shapes do not cause their gate mechanisms to inadvertently open regardless of how they become oriented. Connectors (hooks, carabiners, and D-rings) must be capable of supporting at least 5,000 lbs. (22.2 kN). Do not use equipment that is not compatible. Non-compatible connectors may unintentionally disengage (See Figure 4). Connectors must be compatible with the anchorage or other system components (See Figure 5). Connectors must be compatible in size, shape, and strength. Self-locking snap hooks and carabiners are required by ANSI Z359 and OSHA guidelines. Contact Safewaze if you have any questions about compatibility.



NOTE: SOME SPECIALTY CONNECTORS HAVE ADDITIONAL REQUIREMENTS. CONTACT SAFEWAZE WITH QUESTIONS.

FIGURE 4 - UNINTENTIONAL DISENGAGEMENT

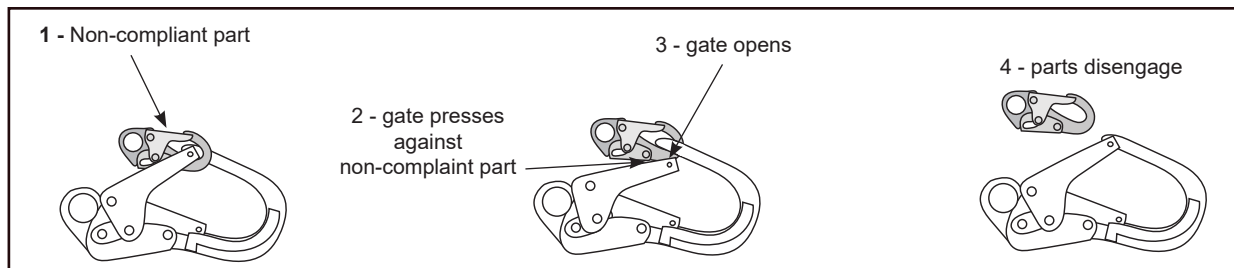

Using a connector that is undersized or irregular in shape (1) to connect a snap hook or carabiner could allow the connector to force open the gate of the snap hook or carabiner. When force is applied, the gate of the hook or carabiner presses against the non-complaint part (2) and forces open the gate (3). This allows the snap hook or carabiner to disengage (4) from the connection point.

9.0 MAKING CONNECTIONS

Snap hooks and carabiners used with this equipment must be double locking and/or twist lock. Ensure all connections are compatible in size, shape and strength. Do not use equipment that is not compatible. Ensure all connectors are fully closed and locked.

Safewaze connectors (snap hooks and carabiners) are designed to be used only as specified in each product's user instructions. See Figure 5 for examples of inappropriate connections. Do not connect snap hooks and carabiners:

- To a D-ring to which another connector is attached.
- In a manner that would result in a load on the gate (with the exception of tie-back hooks). NOTE: Large snap hooks must not be connected to objects which will result in a load on the gate if the hook twists or rotates, unless the snap hook complies with ANSI Z359.12 and is equipped with a 3,600 lb (16 kN) gate. Check the marking on your snap hook to verify its compatibility.

FIGURE 5 - INAPPROPRIATE CONNECTIONS

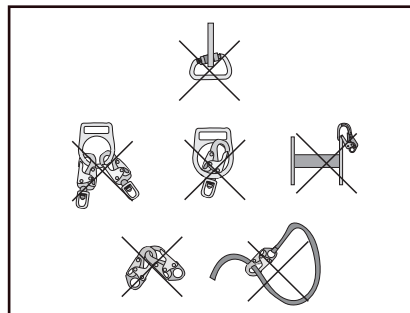

10.0 BUCKLE TYPE AND OPERATION

FIGURE 6 - BUCKLE OPERATION

MATING BUCKLE

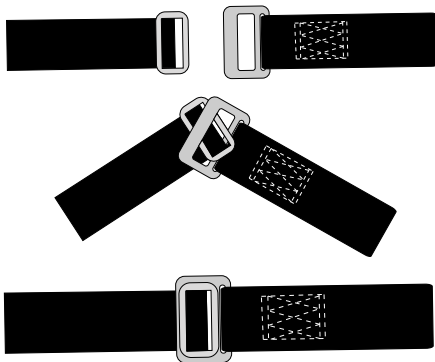

QUICK-CONNECT BUCKLE

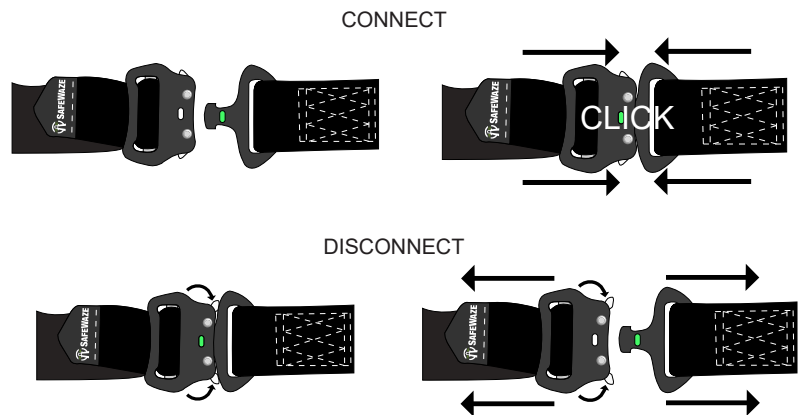

TONGUE BUCKLE

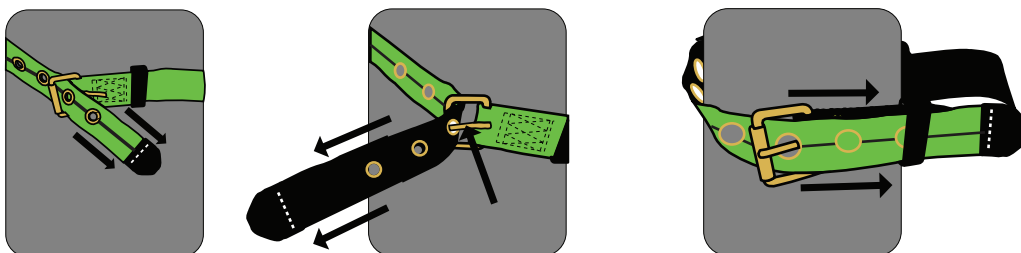

10.1 TORSO ADJUSTER TYPE AND OPERATION

Safewaze FBHs utilize 3 types of adjusters (adjuster type depends on harness model). Figure 7 indicates the Torso Adjuster options available and the proper operation of each type.

FIGURE 7 - TORSO ADJUSTER OPERATION

QUICK TORSO ADJUSTER

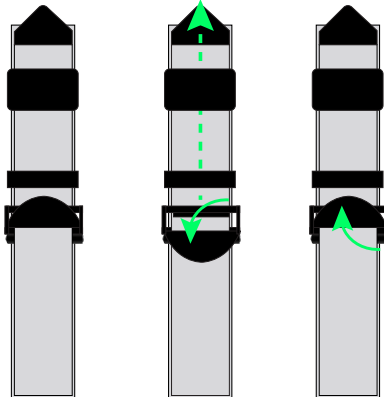

To operate the Quick Torso Adjuster:

- Step 1:** Push down on the Quick Adjuster tab which releases tension on the torso strap webbing.
- Step 2:** Pull up on the free end of the torso strap to shorten, or push downward on the Quick Torso Adjuster to lengthen the FBH torso straps.
- Step 3:** Release the Quick Adjuster tab once torso strap is proper adjusted and stow excess webbing with the elastic webbing keeper.

FRICTION TORSO ADJUSTER

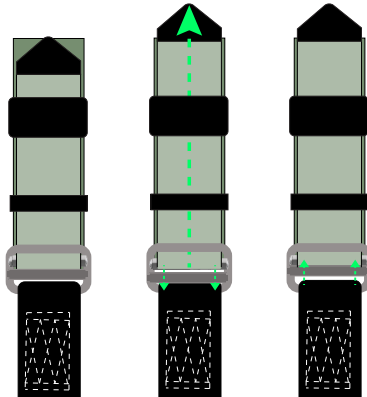

To operate the Friction Torso Adjuster:

- Step 1:** Pull on the free end of the torso webbing to tighten the strap. Loosen the strap by pulling on the free end of the strap and then back the webbing through the Friction Adjuster.
- Step 2:** Release the webbing and stow excess webbing with elastic webbing keeper.

MATING BUCKLE TORSO ADJUSTER

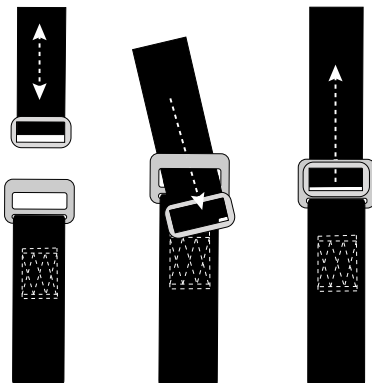

To operate the Mating Buckle Torso Adjuster

- Step 1:** Adjust the webbing length of the male buckle to approximate required length
- Step 2:** Insert the Male Buckle through the slot in the Female Buckle.
- Step 3:** Tighten the free end of the strap so that the Male Buckle is seated securely in the Female Buckle.
- Step 4:** Stow excess webbing with elastic webbing keeper.

11.0 APPLICATION LIMITS

Precautions should be taken in the design and installation of a PFAS in order to avoid hazards such as thermal, chemical, or electrical hazards. Avoid moving machinery, sharp and/or abrasive edges, and any other hazard that could damage or degrade components of the PFAS.

12.0 RESTRICTIONS

Safewaze FBH's are offered in a variety of configurations to suit a multitude of work environments. The unique features of a specific FBH may not be suited for all applications. The following are some restrictions that should be considered prior to use of your Safewaze FBH:

Extended Free Falls: All Safewaze FBH's are designed and rated for 6' (1.83 m) and 12' (3.66 m) FF applications. For 12' FF applications, the user must use a Personal Energy Absorber (PEA) rated for for this level of free fall.

Harsh Chemical Environments: Work operations in a caustic or acidic chemical hazard environment may cause damage to your Safewaze FBH. Damage to your FBH due to chemical exposure can, in some instances, be difficult to detect. In any environment, your Safewaze FBH must be inspected prior to each use, however, a harsh chemical environment can necessitate more frequent inspections. Care should be taken to inspect your FBH before, during, and after each use. A harsh chemical environment may also cause a need for more frequent replacement of your FBH.

Welding, Arc Flash, High Heat Environments: If work operations are conducted in an environment where the FBH may be exposed to extremely high temperatures, the user should choose a FBH specifically designed for these environments. Specific Safewaze FBH's are available for welding, fire resistance, and ARC Flash environments.

Heavyweight: Although ANSI Z359.11 specifies a weight capacity range of 130 to 310 lbs. (59 to 140 kg), most Safewaze FBH's have a maximum weight capacity of up to 420 lbs. (191 kg). If the user has a weight that exceeds the ANSI max weight of 310 lbs. (140 kg), it should be ensured that other components of the PFAS are rated for a heavyweight user.



IMPORTANT: The components of a PFAS used in conjunction with the Safewaze FBH should meet the requirements of the ANSI Z359 Fall Protection Code.

13.0 FBH PRE-USE INSPECTION

Upon receiving your Safewaze Full Body Harness, remove the harness from the packaging and fully inspect harness for possible damage that may have occurred during shipping.

Prior to each use, inspect for the following conditions:

- Inspect the webbing of the harness for cuts, frays, broken stitching, damage from heat or chemical exposure, or other defects related to excessive wear or abrasion.
- Inspect the harness for indications that it has been exposed to fall arrest forces. All Safewaze FBH's are equipped with two load indicators (one on each back torso strap). If either of the load indicators have been deployed (See Figure 7) remove the FBH from service and dispose of as described in Section 6.5.
- Inspect FBH labeling to ensure that they are legible and present on the harness. If any labeling is illegible, or missing, remove the FBH from service.

14.0 HARNESS SIZING AND FIT

Proper fit of a Safewaze FBH is critical in ensuring the proper function of the harness and associated fall protection equipment in the event of a fall. Failure to properly size and fit a harness to the user can prevent the harness from performing in a manner that effectively protects the user. Figure 8 illustrates proper sizing of Safewaze FBHs based upon the users height and weight. This sizing is based upon average body dimensions. Sizing for each individual user should be verified through the donning of harness to ensure proper function and fit.

FIGURE 8 - HARNESS SIZING CHART

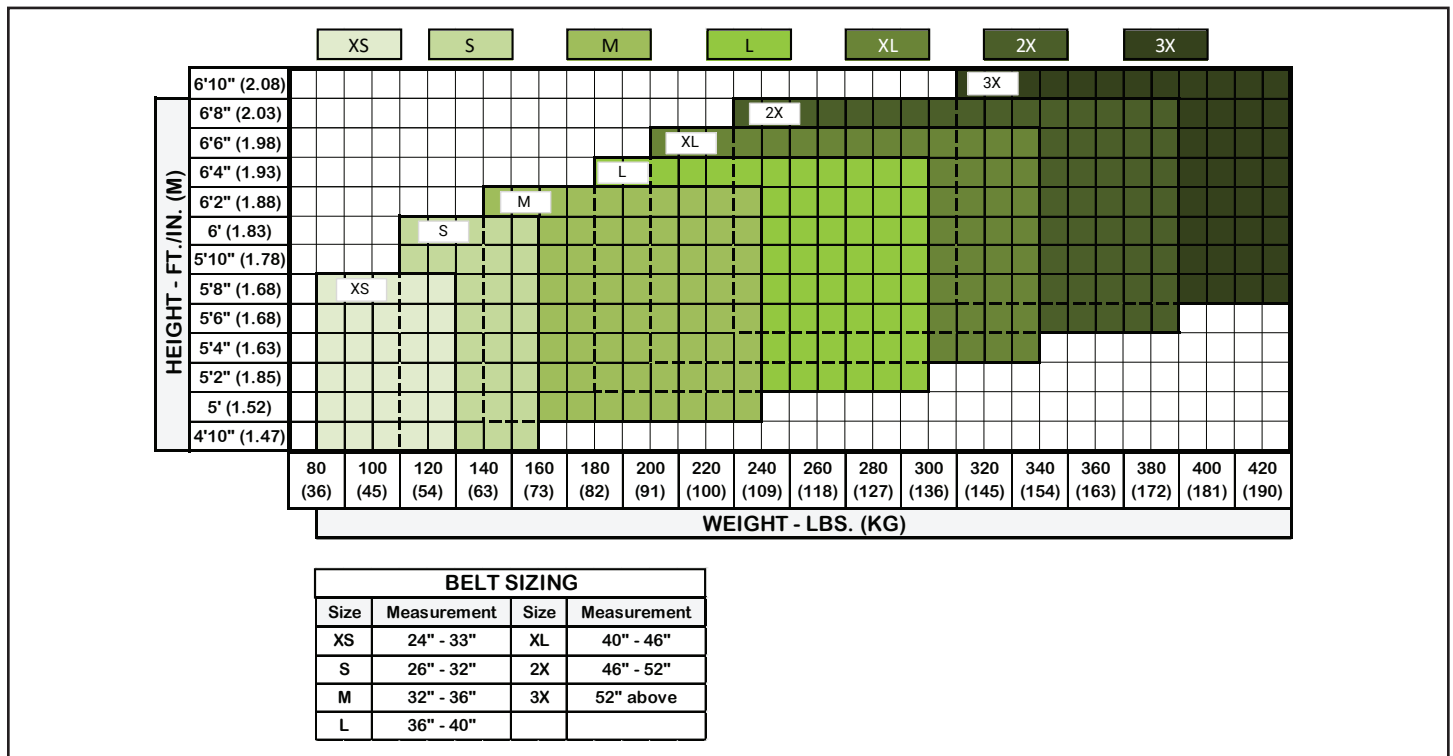

All Safewaze FBHs include sewn in Load Indicators which indicate if the harness has been subjected to fall arrest forces. The Load Indicators are located on the rear torso straps of the harness. Figure 9 indicates the Load Indicators in a Non-Deployed and Deployed status. Should pre-use or scheduled inspection(s) reveal that either of the Load Indicators are Deployed, the harness must be removed from service and destroyed. See Section 19.5 of this manual for disposal guidance.

FIGURE 9 - FBH LOAD INDICATORS

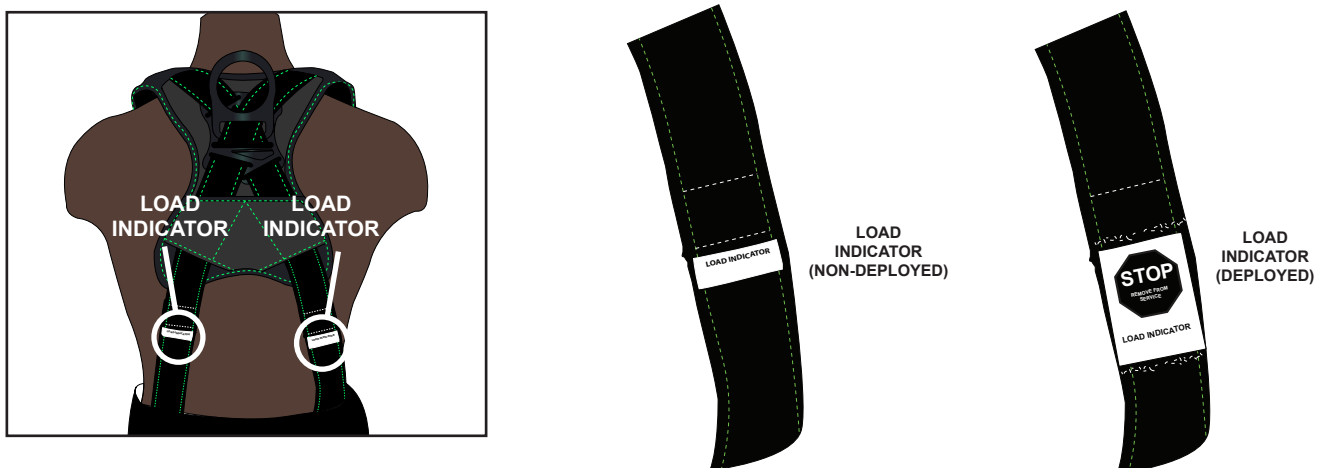

15.0 DONNING AND ADJUSTING THE HARNESS

Safewaze harnesses are offered in a variety of configurations, which can include mating buckle or quick-connect buckles, and some styles which offer tongue buckle leg adjustment. The following sequence of steps in donning the harness are correct regardless of harness configuration. See Figure 10 for illustration of steps.

FIGURE 10 - HARNESS DONNING

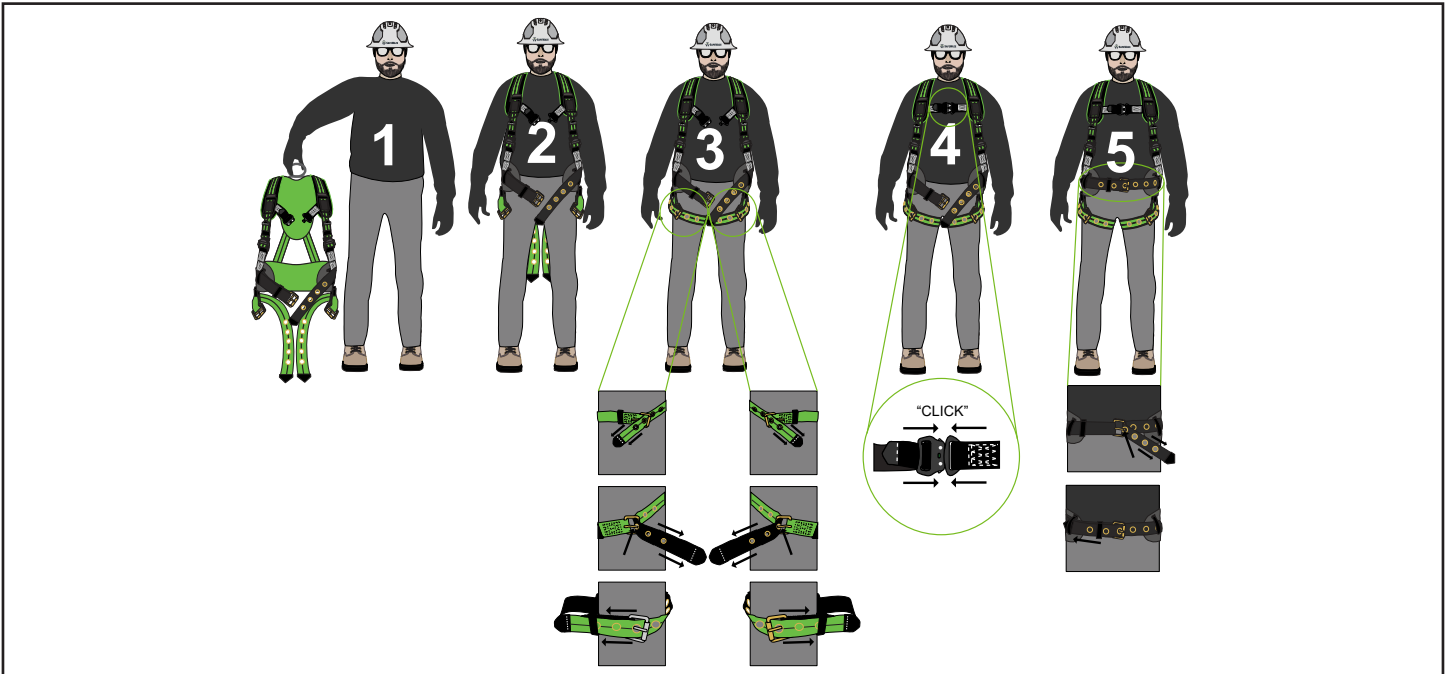

Step 1: Disconnect chest and leg buckles. If so equipped, also disconnect the waist belt buckle. Hold the FBH by the dorsal D-ring allowing the harness to hang freely. Ensure that harness is not twisted or tangled.

Step 2: Slip arms in arm openings as you would if donning a vest.

Step 3: Adjust length of the leg straps to a point that will provide a snug fit. Connect the leg buckles (Mating Buckle or Quick Connect) and again ensure snug fit of the leg strap. In the event your harness is equipped with Grommet Legs, pull the free end of the webbing through the buckle assembly until proper fit is achieved. Insert the tongue of the buckle assembly through the leg strap grommet, and thread the free end of the leg strap through the plastic and web keepers to secure excess webbing.

Step 4: Adjust chest strap to a location just under the sternum. Shorten or lengthen the chest strap to provide a snug fit across the chest. Connect the chest buckle (mating buckle or quick-connect) and once again ensure proper placement and tension of the strap (See Figure 6 for mating buckle operation).

Step 5: If FBH is equipped with a waist belt, adjust length in same manner as tongue buckle legs and fasten for snug fit.

15.1 DON AND ADJUST CROSSOVER STYLE HARNESS

Step 1: Hold both shoulder straps of the harness in your left hand. Slide the shoulder straps over the left shoulder. With both straps still on the left shoulder, take the right shoulder strap and slide over top of head to right shoulder.

Step 2: The harness is properly positioned on the body when the head is centered between the shoulder pads with the fall arrest attachment positioned in the upper middle portion of the back, between the shoulder blades. The front attachment point should be centered on the sternum of the user.

Step 3: Connect leg buckles in the same manner as a standard Full Body Harness.

16.0 BWB INSTALLATION AND USE

16.1 SW-9012 BEHIND THE WEB BRACKET

The SW-9012 comes fully assembled and ready for installation. No tools are required for installation of the bracket onto harness. Use the following instructions and Figure 11 to install the SW-9012 Behind the Web Bracket:

To Fasten To Harness:

1. Ensure that the curved portion of SW-9012 is in a downward orientation relative to the harness (See Figure 11, Dwg. 1).
2. Simultaneously depress both locking buttons (A) and (B) (See Figure 11, Dwg. 2) and slide the bracket open as indicated (See Figure 11, Dwg. 3).
3. With the bracket open, install dual leg retractables onto the bracket via the swivel tops of each. Swivels should be hanging on the curved portion of bracket.
4. While pressing in on locking button (A) slide the bar behind both loops of webbing at dorsal D-ring until the bar locks back into place.
5. Check the locking function of the bracket by attempting to slide the bracket open WITHOUT depressing locking buttons (A) or (B). Bracket bar should not move and the bracket is now locked into place.

FIGURE 11 - SW-9012 DUAL BRACKET INSTALLATION

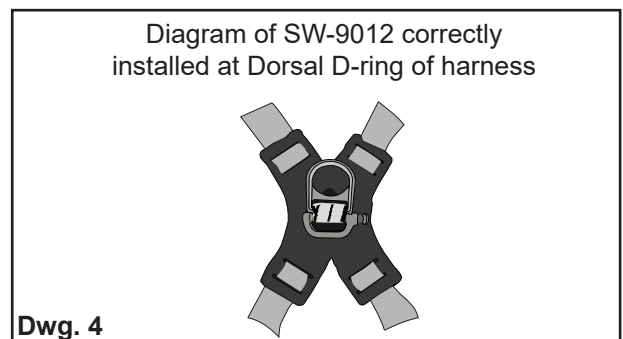
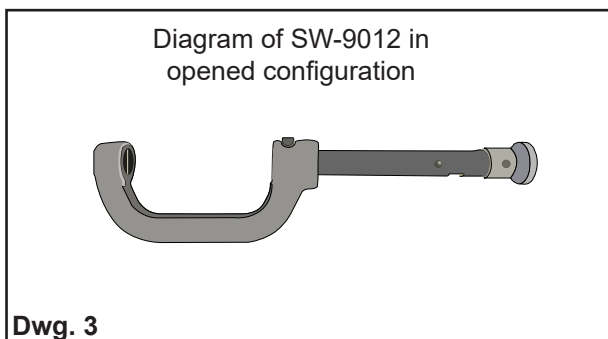
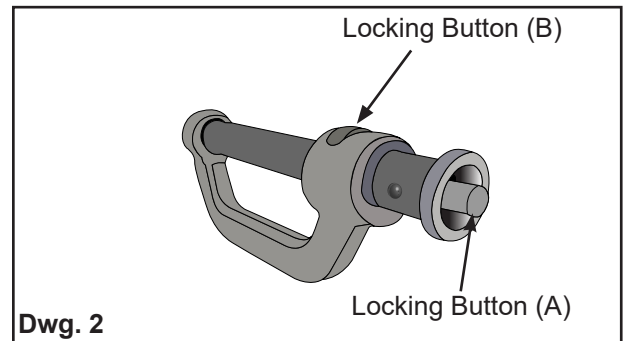
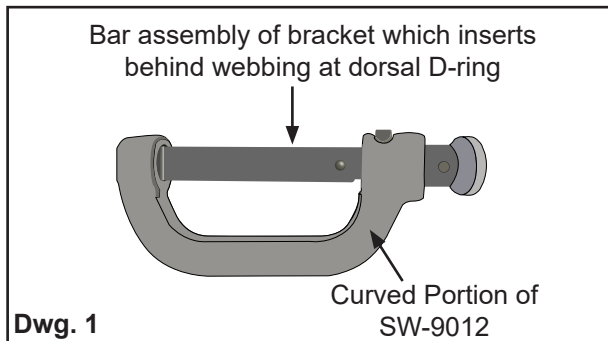

16.2 9013 BEHIND THE WEB BRACKET

The 9013 bracket comes fully assembled and ready for installation. No tools are required for installation of the bracket onto harness. Use the following instructions and Figure 12 to install the 9013 Behind the Web Bracket.

To Fasten To Harness:

1. Ensure that the curved portion of 9013 is in a downward orientation relative to the harness (See Figure 12, Dwg. 1).
2. Simultaneously depress both locking button (A) and and slide lock (B) (See Figure 12, Dwg. 2) to swing the bracket open (See Figure 12, Dwg. 3).
3. With the bracket open, install dual leg retractables onto the bracket via the swivel tops of each. Swivels should be hanging on the curved portion of bracket.
4. Slide the bar behind both loops of webbing at dorsal D-ring. Swing the bracket closed until it locks into place.
5. Check the locking function of the bracket by attempting to swing the bracket open WITHOUT depressing locking button (A) or slide lock (B). Bracket bar should not move and the bracket is now locked into place.
6. Dual leg retractables can be easily installed and removed from bracket by once again depressing both locking button (A) and slide lock (B), which allows bracket to swing open without complete removal from harness.

FIGURE 12 - 9013 DUAL BRACKET INSTALLATION

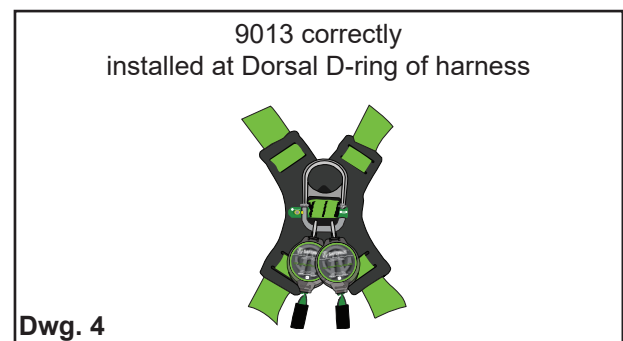
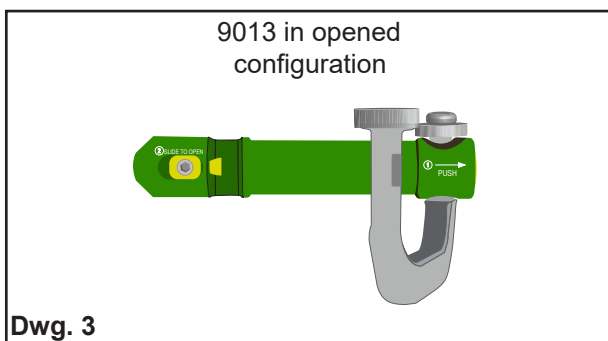
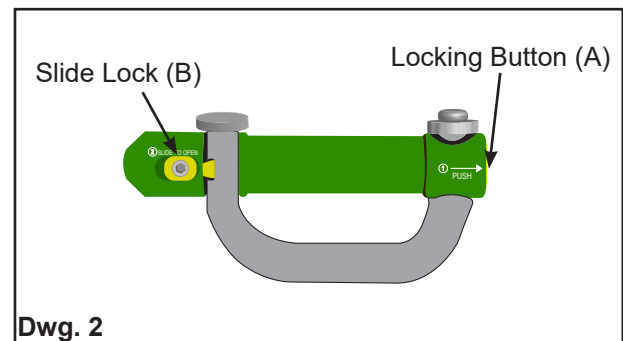
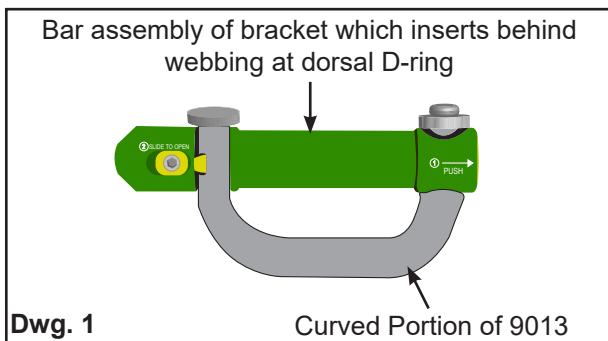

16.3 FS1014-TL-BLACK-BWB

The behind the web bracket comes fully assembled and ready for installation. No tools are required for installation of the bracket onto harness. Use the following instructions and Figure 13 to install the bracket:

To Fasten To Harness:

1. Unfasten the two small brackets on the green retractable spacer off of the carabiner.
2. Slide the green spacer around to the side of carabiner to allow opening of the carabiner gate.
3. Open the carabiner gate and slide spacer off of carabiner and remove one of the retractables.
4. Holding gate open on carabiner, insert the open end of carabiner through the webbing loops at Dorsal D-ring on the X Pad of harness. Ensure that both loops of webbing on X Pad are inside of carabiner.
5. With carabiner gate still open, slide the removed retractable and green spacer back onto carabiner and allow carabiner gate to close.
6. Slide the green retractable spacer back over the gate of carabiner and snap the two small brackets back into place on carabiner, with the web loops positioned between these two small brackets.

FIGURE 13 - FS1014-TL-BLACK-BWB INSTALLATION

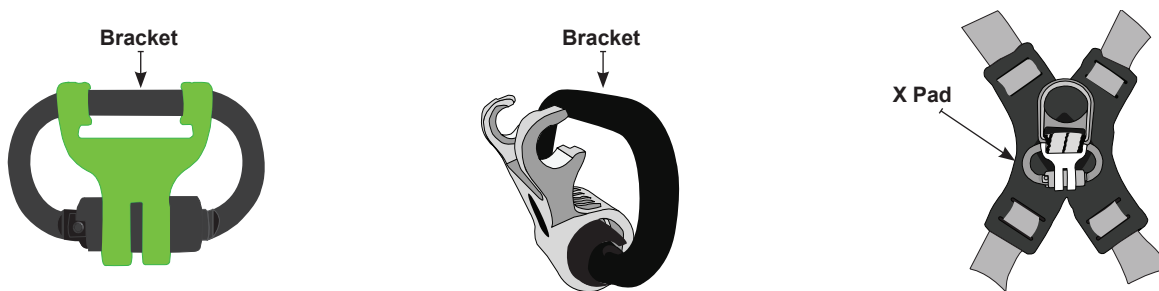

16.4 FS-EX313 DUAL LEG BRACKET

If choosing a Dual Leg SRL equipped with the FS-EX313 Dual Leg Bracket, installation and removal is a quick and easy process. Units ordered with the FS-EX313 come fully assembled with the bracket attached to the SRLs. Simply attach the units to the dorsal D-ring of the harness with the provided double locking carabiner (See Figure 14).

FIGURE 14 - FS-EX313 INSTALLATION

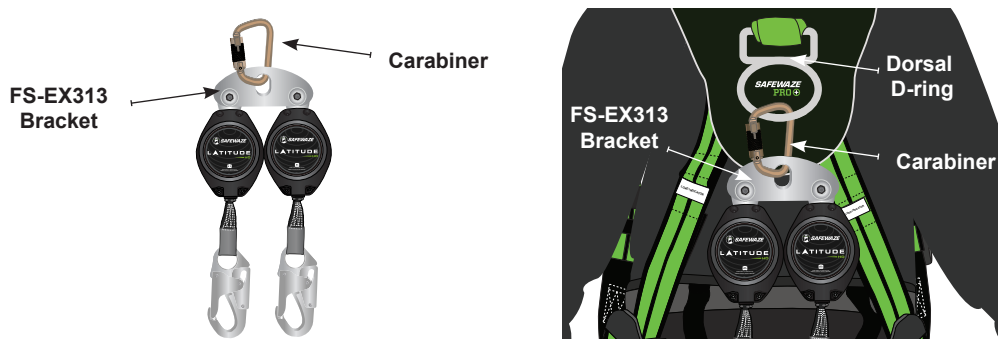

16.5 DORSAL LINK

Some models of the Safewaze FBH may include an integral Dorsal Link connection for installation of Dual SRLs. The Dorsal Link offers a simple connection for Dual Leg SRLs, while also acting as a Dorsal D-ring extender. Simply attach the Dual Leg SRLs to the looped end of the Dorsal Link with a dual leg bracket or double locking carabiner. Figure 15 illustrates the Dorsal Link, and attachment of dual leg SRLs.

FIGURE 15 - DORSAL LINK SRL INSTALLATION

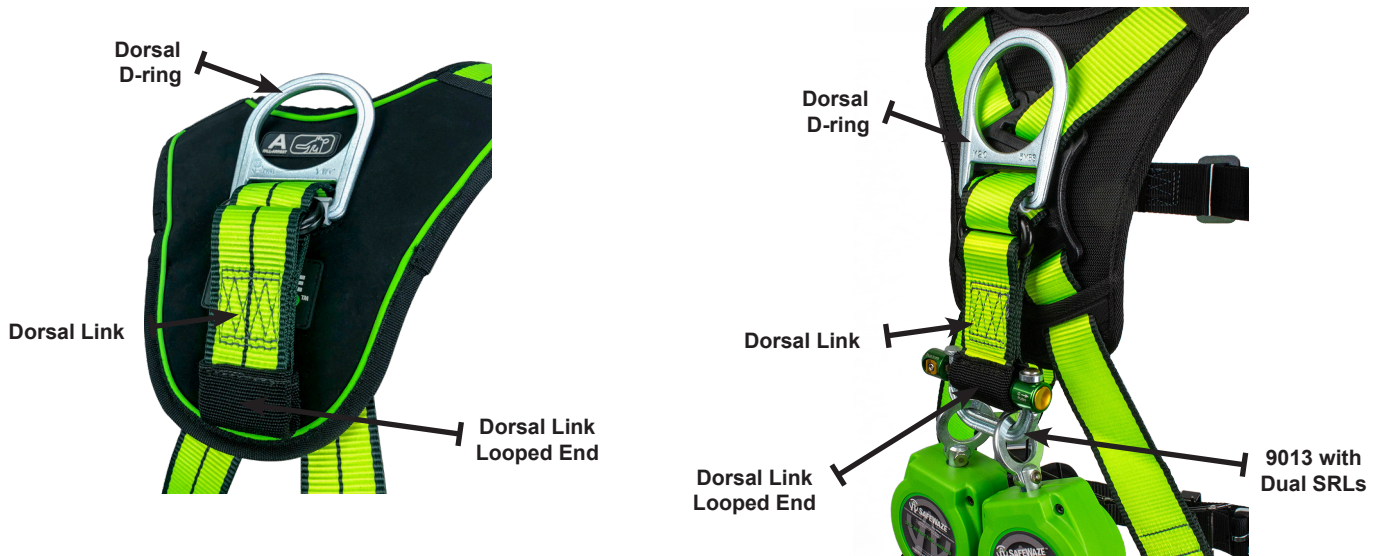

16.6 INTEGRATED DORSAL ATTACHMENT POINT (DAP)

The Integrated Dorsal Attachment Point (DAP) comes as standard equipment on certain Safewaze Harnesses. This enhanced Dorsal D-ring pad offers a quick and convenient connection of SRLs. Install the connector through the preformed DAP on the D-ring pad and lock closed as normal to secure. The DAP can be used with any of the Safewaze Behind the Web brackets. If using the FS1014-TL-BLACK-BWB with the DAP, the green retractable spacer clip is not required and should not be used. Figure 16 illustrates a typical DAP SRL attachment to the Full Body Harness.

FIGURE 16 - INTEGRATED DORSAL ATTACHMENT POINT SRL INSTALLATION

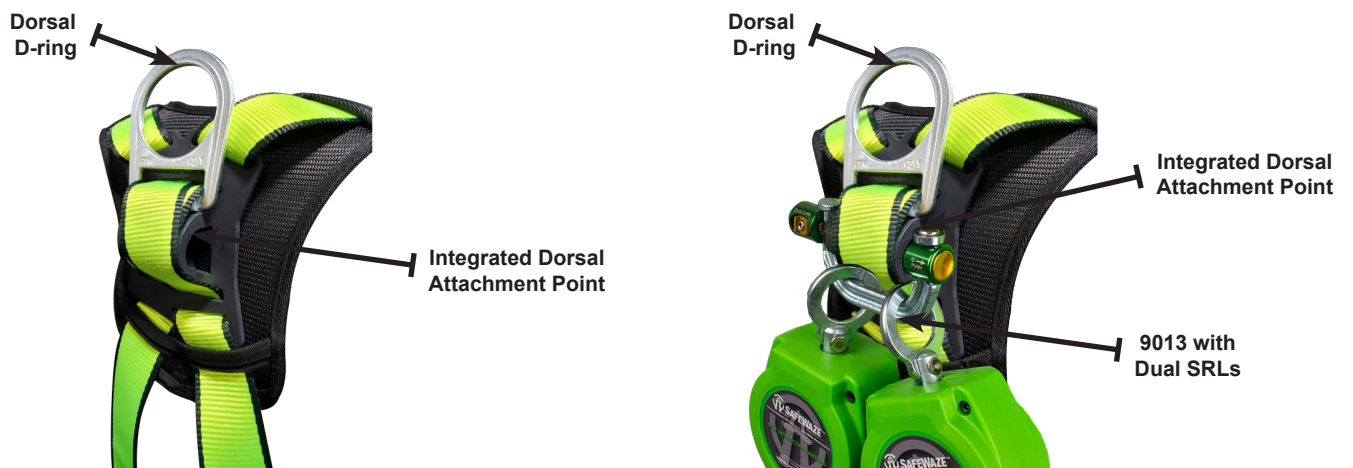

17.0 USE



WARNING: Contact Safewaze if you have questions, regarding compatibility of this equipment. Do not alter or misuse this equipment. Some subsystem components could affect the performance and the operation of this equipment. Do not connect this product to moving machinery, or hazards that include chemical, electrical or gaseous characteristics. Failure to comply with this warning could result in serious injury or death.



WARNING: Consult your doctor if there is reason to doubt your fitness to safely absorb the shock from a fall arrest. Age and fitness seriously affect a worker's ability to withstand falls. Pregnant women or minors must not use Safewaze FBH's. Failure to heed this warning may result in serious injury or death.

17.1 OPERATION

Inspect the FBH, as described in Section 19, before using the equipment. Refer to Figure 17 for the most common FBH connections. Ensure connections are compatible in size, shape, and strength. Ensure hooks are fully closed and locked.

17.2 AFTER A FALL

Should the Safewaze Body Harness be exposed to an the force of a fall, or shows damage consistent with the effects of a fall, it must be IMMEDIATELY removed from service. Equipment must then be disposed of (See Section 19.5).

17.3 HARNESS CONNECTIONS

Figure 17 illustrates typical harness connections when working at heights, including work positioning and rescue operations. When using a snap hook to make a connection, ensure roll-out cannot occur (See Figure 4). Do not use snap hooks or carabiners that will not completely close over the anchor point. This includes traditional overhead anchor point tie off, SRL housing attachment to dorsal D-ring, and 100% tie off. Follow the manufacturer's instructions supplied with each system component.

FIGURE 17 - TYPICAL HARNESS CONNECTIONS

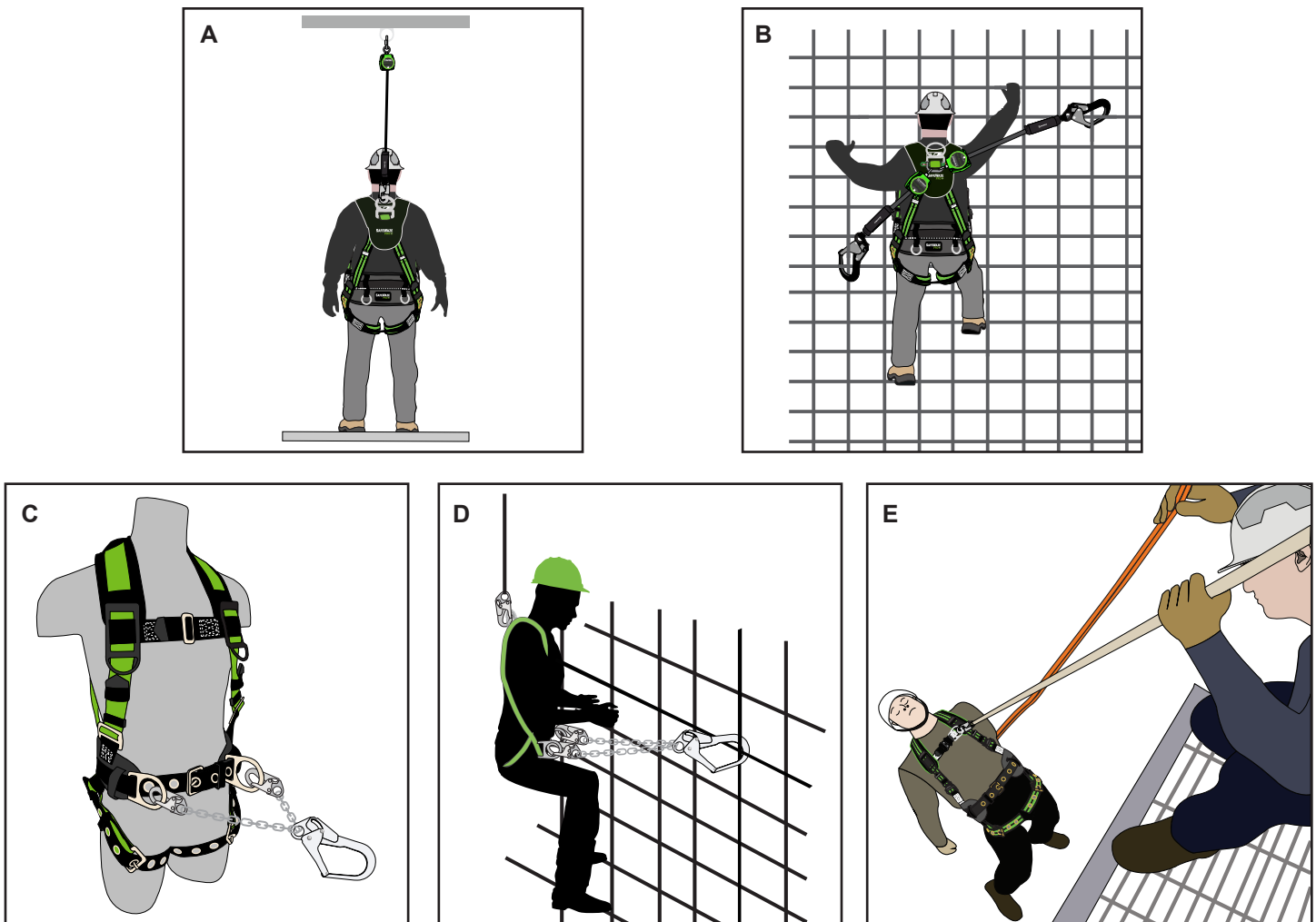

17.4 LANYARD KEEPER

Certain projects may require the use of a dual leg lanyard or SRL. If using a dual leg device, the user must ensure that the unused leg of the Lanyard/SRL is properly stowed when not actively in use. Safewaze Full Body Harnesses are equipped with two lanyard keepers (one on each torso strap). These lanyard keepers provide a location to attach the unused Lanyard/SRL leg. Proper use of the lanyard keepers ensures that the unused leg of the device remains easily accessible to the user, as well as keeping it clear of ongoing work operations. Figure 18 indicates the location of the lanyard keepers and an example of proper use.

FIGURE 18 - LANYARD KEEPERS

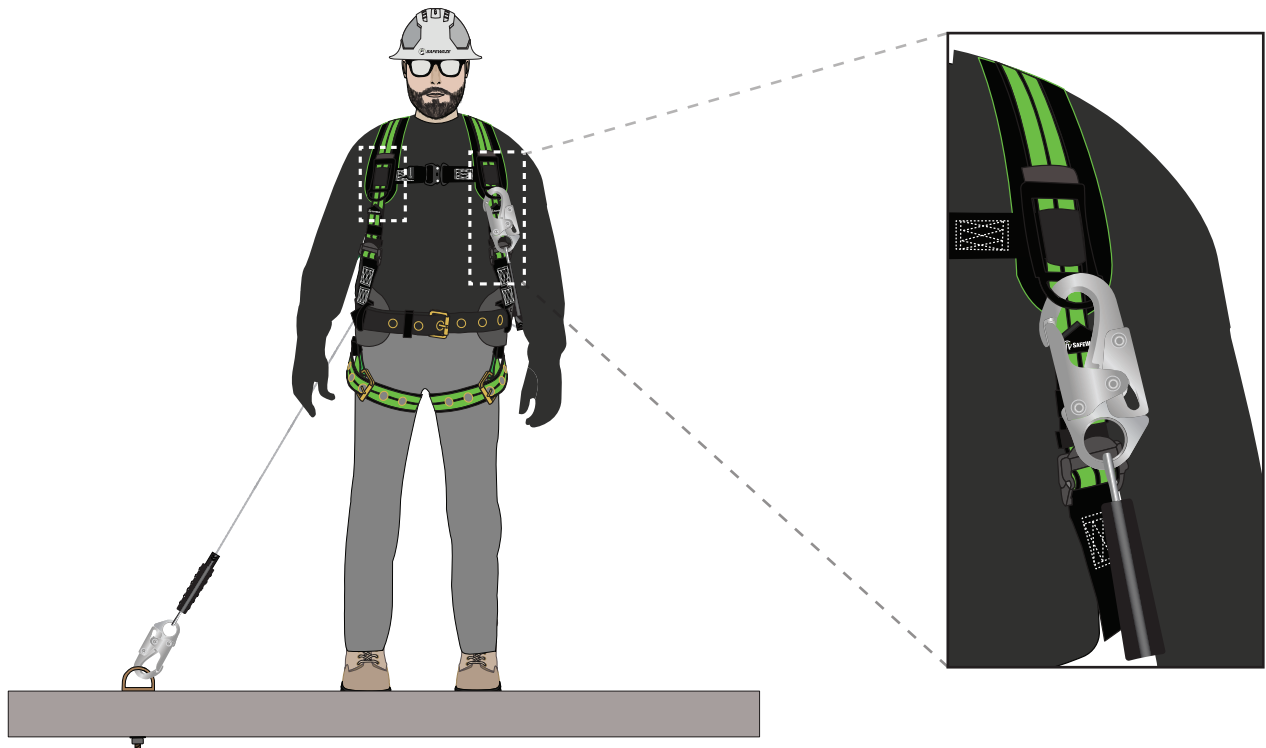

17.5 REPLACABLE / REUSABLE LANYARD KEEPER

Full Body Harness mounted Lanyard Keepers are designed to break away in the event of a fall. If the unused lanyard leg becomes caught during the fall, the Lanyard Keeper will break away. This prevents forces from the tightening of the lanyard from transferring to the Full Body Harness and the user wearing it. In the event that a Lanyard Keeper is damaged or broken, Safewaze offers an easily installed replacement Lanyard Keeper (Part# 021-9038). Figure 19 illustrates installation of the replacement Lanyard Keeper onto a typical Safewaze FBH.

To Fasten To Harness:

1. Grasp replacement Lanyard Keeper webbing and pull apart to open webbing to full length (See Figure 19, Dwg. 1).
2. Take the free end of the Lanyard Keeper webbing and position it above the existing Lanyard Keeper (See Figure 19, Dwg. 2).
3. Insert the free end of the webbing behind the web loop and pull downward until new Lanyard Keeper is centered behind the web loop (See Figure 19, Dwg. 3).
4. Fold the bottom section of the Lanyard Keeper webbing upward and re-attach to the opposite end of the webbing via the hook and loop fasteners (See Figure 19, Dwg. 4).
5. Rotate the Lanyard Keeper in a downward motion until the plastic loop is in the correct orientation (See Figure 19, Dwg. 5).
6. Park lanyard hardware as needed (See Figure 19, Dwg. 6).

FIGURE 19 - REPLACEABLE / REUSABLE LANYARD KEEPERS INSTALLATION

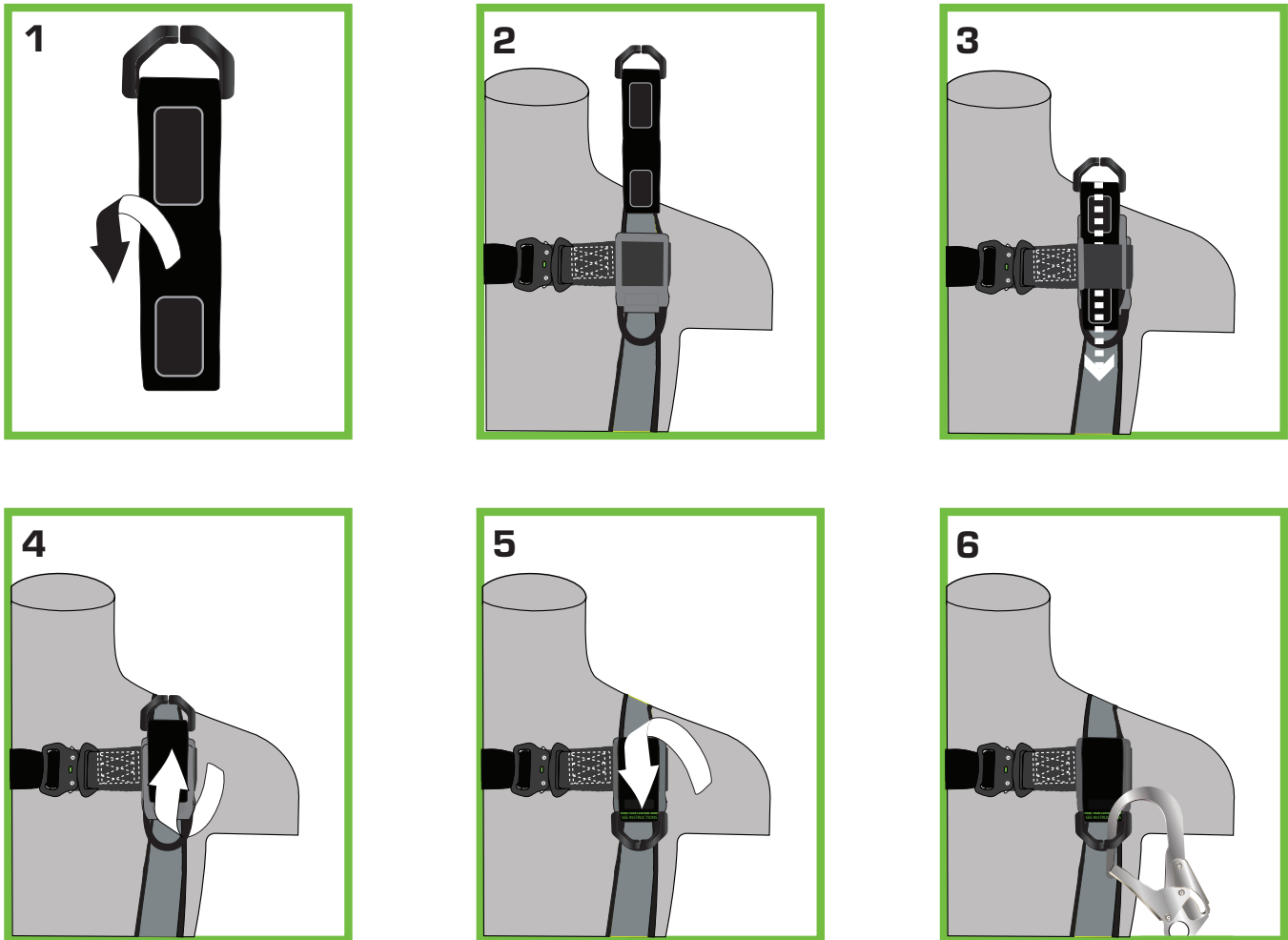

18.0 MAINTENANCE, CLEANING, & STORAGE

18.1 MAINTENANCE

Remove the Safewaze FBH from use if the FBH has been subjected to fall arrest forces or inspection reveals an unsafe or defective condition. If unsafe or defective condition is found, dispose of the FBH as recommended in section 19.5.

18.2 CLEANING

Cleaning procedures for Safewaze FBH's are as follows:

If webbing becomes soiled or requires cleaning, use water and a mild soap solution.

Clean labels to maintain legibility.

Hang FBH and allow to fully dry before using. Do not dry the harness in a commercial type dryer, or use heated air to dry.

18.3 STORAGE

Store Safewaze FBHs in a cool, dry, clean environment out of direct sunlight. Avoid areas where chemical vapors may exist. Thoroughly inspect the FBH after any period of extended storage.

19.0 INSPECTION

19.1 BEFORE EACH USE

Inspect the webbing of the harness for cuts, frays, broken stitching, damage from heat or chemical exposure, or other defects related to excessive wear or abrasion.

Inspect the harness for indications that it has been exposed to fall arrest forces. All Safewaze FBH's are equipped with two load indicators (one on each back torso strap). If either of the load indicators have been deployed (See Figure 9) remove the FBH from service and dispose of as described in Section 19.5.

Inspect FBH labeling to ensure that they are legible and present on the harness. If any labeling is illegible, or missing, remove the FBH from service.

19.2 INSPECTION FREQUENCY

In addition to inspection prior to each use, the FBH must be inspected annually by a competent person other than the user. Severe or harsh environments may require more frequent inspections.

19.3 UNSAFE OR DEFECTIVE CONDITIONS

Figure 20 shows examples of equipment damage. Equipment inspectors must be trained to look for damage to components of the FBH as illustrated in Figure 20, as well as other damage that may occur. If inspection reveals an unsafe or defective condition remove the FBH from service.

FIGURE 20 - EXAMPLES OF EQUIPMENT DAMAGE

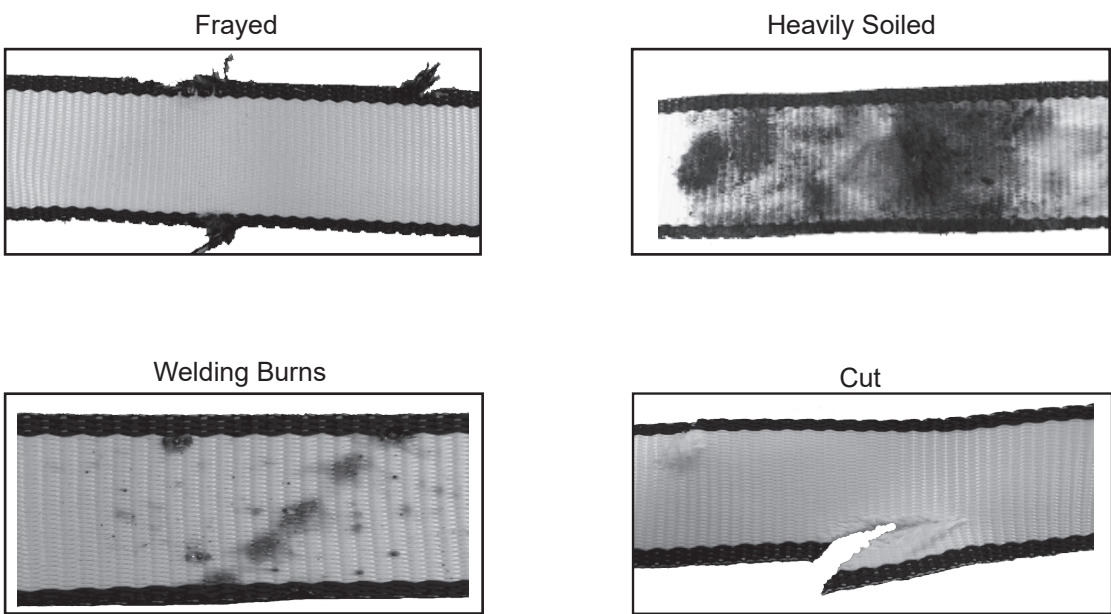
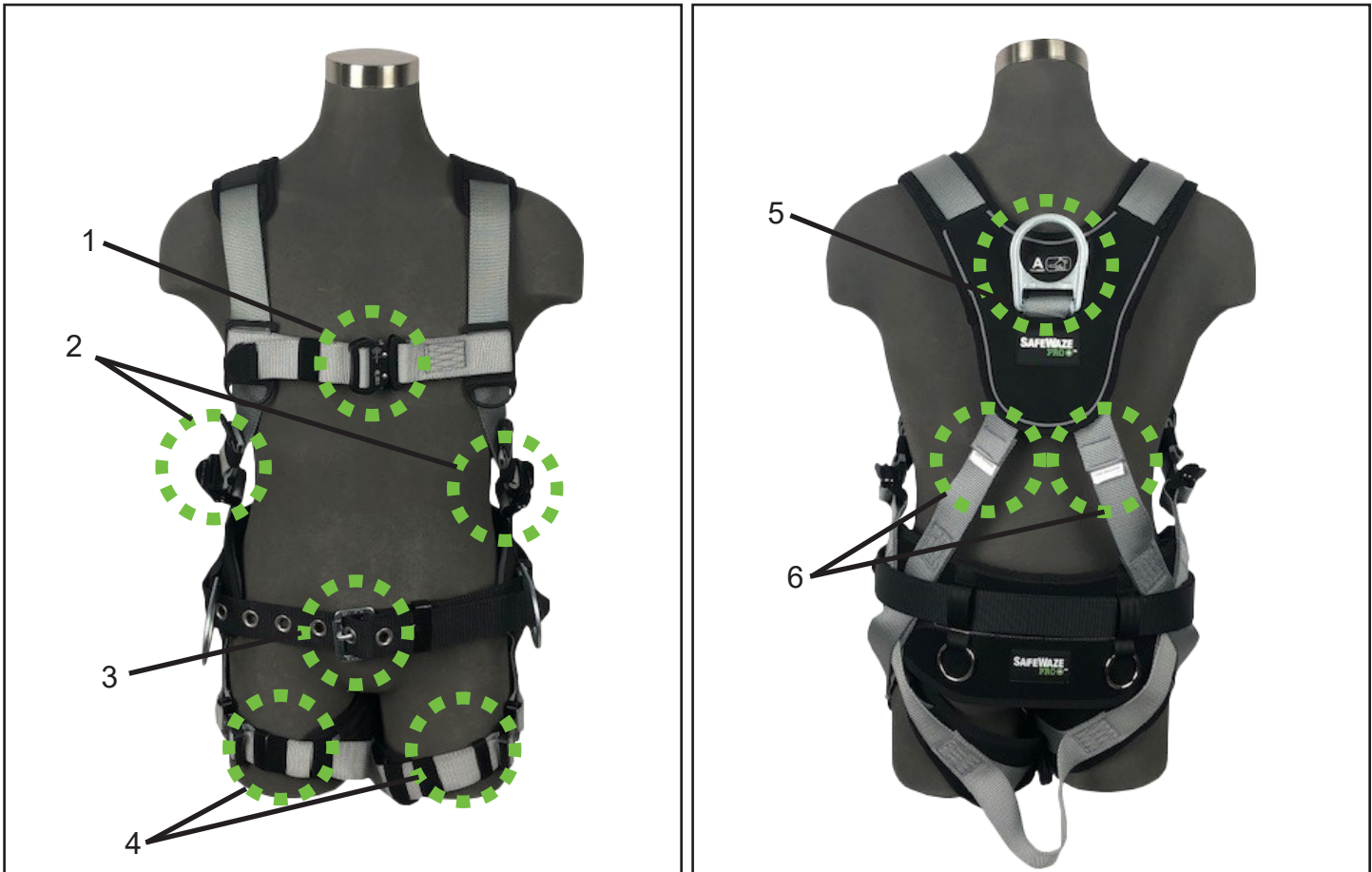

FIGURE 21 - INSPECTION DIAGRAMS



1. Inspect chest strap to include stitching and buckle assembly. Ensure no stitches are broken, frayed, or cut. Inspect that buckle assembly functions properly and does not display any excessive corrosion. Inspect all harness webbing and stitching for possible damage or defects.
2. Inspect sizing adjusters for proper function and ensure correct sizing of harness for use.
3. If so equipped, inspect belt assembly for proper function of buckle and ensure that no excessive corrosion exists.
4. Inspect leg straps for proper function of buckles and if any excessive corrosion is present. If leg straps are grommet style, ensure that no grommets are loose or missing.
5. Inspect dorsal D-ring assembly. Ensure that dorsal D-ring has no excessive corrosion and that web loop is intact with no cuts, fraying, or damage.
6. Check that load indicators are present on harness and non-deployed.
(See Figure 9 for example of deployed load indicator)

19.4 PRODUCT LIFE

The working life of Safewaze FBH's are determined by work conditions, care and inspection provided. As long as the FBH passes inspection, it may remain in service.

19.5 DISPOSAL

Dispose of the Safewaze FBH if it has experienced fall arrest forces or inspection reveals an unsafe or defective condition. Before disposing of the FBH, cut the harness into separate sections to prevent future use.

20.0 LABELING

FIGURE 22 - LABEL EXAMPLES

ANSI Z359.11-2021
ANSI Z359 Recognizes the use of this harness only within the capacity range of:
130-310 lbs.



SAFEWAZE
225 Wilshire Ave. SW
Concord, NC 28025
USA
(800) 230-0319
www.safewaze.com



FS99185-E-QC-2X
MADE IN CHINA

MODEL #: FS99185-E-QC-2X

DESCRIPTION: V-Line Full Body Harness:
1D, QC Chest, TB Legs (2X)

SIZE: XX-Large **CLASS:** A

SERIAL #: 09600001 **MFG DATE:** 04/2022

-MATERIALS: Polyester webbing, steel hardware

-MAX WEIGHT CAPACITY: (ANSI 130-310 lbs.)
(OSHA 420 lbs.)

MUST FOLLOW ALL MFG'S INSTRUCTIONS INCLUDED WITH THE EQUIPMENT AT TIME OF SHIPMENT

Meets: ANSI Z359.11-2021, OSHA 1926.502 and 1910.140

DO NOT REMOVE LABEL

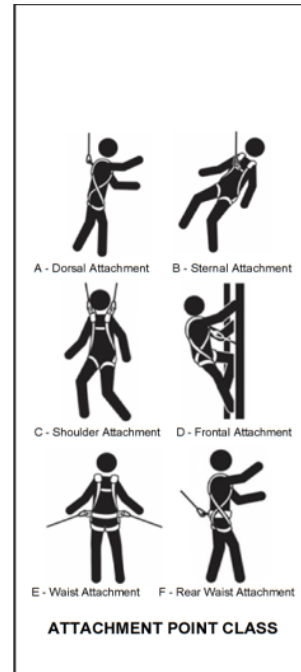

 **WARNING**

Manufacturer's instructions supplied with this product at time of shipment must be read and understood prior to use. Failure to follow these instructions could result in serious injury or death. Contact Safewaze if instruction is needed. Inspect before each use. Do not use if wear or damage is present. Do not alter or modify this equipment in any way. Any unit which has been exposed to fall arrest forces should be immediately removed from service and destroyed. Connecting snap and d-ring must be compatible in size, shape, and strength. Not flame or heat resistant unless otherwise specified. **DO NOT REMOVE THIS LABEL.**

-Only make compatible connections
-Inspect before each use
-If load indicator is deployed and/or subjected to a fall, remove from service

WARNING: Do not exceed the capacity of this or other system components. Capacity is the combined weight for which the component is designed to be used. Combined weight includes the user's body weight, clothing, tools, and any objects carried. Contact Safewaze for more information.

	J	F	M	A	M	J	J	A	S	O	N	D

INSPECTION LOG

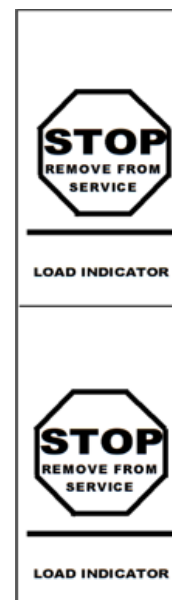



225 Wilshire Ave
Concord, NC 28025

FS99185-E-QC

FULL BODY HARNESS
SIZE: UNIVERSAL



FS99185-E-QC
MADE IN CHINA
www.safewaze.com

21.0 INSPECTION FORM

Product lifetime is indefinite as long as it passes pre-use and Competent Person inspections. User must inspect prior to each use. Competent Person other than the user must complete formal inspection at least annually.



Manufacturer: _____ Company: _____
 Model Number: _____ Name of Inspector: _____
 Description: _____ Signature: _____
 Serial Number: _____ Date of Inspection: _____
 Lot Number: _____ In-Service Date: _____
 Date of Manufacture: _____

Harness Configuration: Chest Strap PT TB Leg Straps PT TB Waist Belt Yes No

LABELS & MARKINGS	PASS	FAIL	NOTE
	<input type="checkbox"/>	<input type="checkbox"/>	<input type="checkbox"/>
Label (Intact and Legible)	<input type="checkbox"/>	<input type="checkbox"/>	<input type="checkbox"/>
Appropriate ANSI / OSHA / CSA Markings	<input type="checkbox"/>	<input type="checkbox"/>	<input type="checkbox"/>
Inspections are Current / Up-to-Date	<input type="checkbox"/>	<input type="checkbox"/>	<input type="checkbox"/>
Date of First Use	<input type="checkbox"/>	<input type="checkbox"/>	<input type="checkbox"/>
Impact / Fall Indicators Not Deployed	<input type="checkbox"/>	<input type="checkbox"/>	<input type="checkbox"/>

HARDWARE (Buckles & D-Rings)	PASS	FAIL	NOTE
	<input type="checkbox"/>	<input type="checkbox"/>	<input type="checkbox"/>
Signs of Deformity or Damage	<input type="checkbox"/>	<input type="checkbox"/>	<input type="checkbox"/>
Proper D-ring attachment and operation	<input type="checkbox"/>	<input type="checkbox"/>	<input type="checkbox"/>
All Buckles Undamaged and Operational	<input type="checkbox"/>	<input type="checkbox"/>	<input type="checkbox"/>
Corrosion / Pitting / Nicks	<input type="checkbox"/>	<input type="checkbox"/>	<input type="checkbox"/>
Ensure Grommets are Secure / Do Not Move	<input type="checkbox"/>	<input type="checkbox"/>	<input type="checkbox"/>

WEBBING	PASS	FAIL	NOTE
	<input type="checkbox"/>	<input type="checkbox"/>	<input type="checkbox"/>
Shoulder / Chest / Leg / Back Straps	<input type="checkbox"/>	<input type="checkbox"/>	<input type="checkbox"/>
Cuts / Burns / Holes	<input type="checkbox"/>	<input type="checkbox"/>	<input type="checkbox"/>
Paint Contamination	<input type="checkbox"/>	<input type="checkbox"/>	<input type="checkbox"/>
Excessive Wear	<input type="checkbox"/>	<input type="checkbox"/>	<input type="checkbox"/>
Heat / UV Damage	<input type="checkbox"/>	<input type="checkbox"/>	<input type="checkbox"/>

STITCHING	PASS	FAIL	NOTE
	<input type="checkbox"/>	<input type="checkbox"/>	<input type="checkbox"/>
Shoulder / Chest / Leg / Back Straps	<input type="checkbox"/>	<input type="checkbox"/>	<input type="checkbox"/>



NOTES

**If equipment fails inspection
IMMEDIATELY REMOVE FROM SERVICE**

PART NUMBERS COVERED IN THIS MANUAL

018-1000	019-1068	020-1212	020-1371	021-1460	021-1522	021-1612	021-1796
018-1001	019-1069	020-1213	020-1372	021-1461	021-1523	021-1613	021-1797
018-1002	019-1070	020-1214	020-1373	021-1462	021-1524	021-1617	021-1798
018-1003	019-1071	020-1215	020-1374	021-1463	021-1525	021-1618	021-1799
018-1004	019-1072	020-1216	020-1375	021-1464	021-1526	021-1619	021-1802
018-1005	019-1073	020-1217	020-1380	021-1465	021-1528	021-1620	021-1803
018-1006	019-1074	020-1218	020-1381	021-1466	021-1529	021-1621	021-1804
018-1007	020-1143	020-1220	020-1382	021-1467	021-1530	021-1624	021-1805
018-1008	020-1150	020-1221	020-1386	021-1468	021-1531	021-1625	021-1806
018-1009	020-1151	020-1222	020-1387	021-1470	021-1532	021-1626	021-1807
018-1010	020-1152	020-1223	020-1388	021-1471	021-1541	021-1627	021-1810
019-1008	020-1153	020-1224	020-1398	021-1472	021-1542	021-1628	021-1811
019-1020	020-1165	020-1225	020-1399	021-1473	021-1543	021-1637	021-1812
019-1021	020-1166	020-1226	020-1400	021-1474	021-1544	021-1638	021-1813
019-1022	020-1167	020-1228	020-1401	021-1476	021-1545	021-1639	021-1814
019-1023	020-1168	020-1229	020-1412	021-1477	021-1548	021-1640	021-1815
019-1024	020-1169	020-1230	020-1413	021-1478	021-1549	021-1641	021-1817
019-1025	020-1170	020-1231	020-1414	021-1479	021-1550	021-1642	021-1818
019-1026	020-1171	020-1232	020-1415	021-1480	021-1551	021-1644	021-1819
019-1027	020-1172	020-1233	020-1418	021-1481	021-1552	021-1645	021-1820
019-1028	020-1173	020-1234	021-1425	021-1482	021-1553	021-1646	021-1821
019-1029	020-1174	020-1298	021-1426	021-1483	021-1554	021-1647	021-1822
019-1030	020-1180	020-1299	021-1427	021-1484	021-1557	021-1648	021-1823
019-1031	020-1181	020-1300	021-1428	021-1485	021-1558	021-1649	021-1824
019-1032	020-1182	020-1301	021-1429	021-1486	021-1559	021-1651	021-1825
019-1033	020-1183	020-1302	021-1430	021-1487	021-1560	021-1658	021-1826
019-1034	020-1184	020-1303	021-1431	021-1488	021-1571	021-1659	021-1827
019-1035	020-1185	020-1304	021-1433	021-1489	021-1572	021-1660	021-1828
019-1036	020-1186	020-1316	021-1434	021-1490	021-1573	021-1661	021-1829
019-1037	020-1188	020-1322	021-1435	021-1491	021-1574	021-1662	021-1830
019-1038	020-1189	020-1323	021-1436	021-1493	021-1577	021-1663	021-1831
019-1039	020-1190	020-1324	021-1437	021-1494	021-1578	021-1664	021-1832
019-1040	020-1191	020-1325	021-1438	021-1495	021-1579	021-1666	022-1067
019-1041	020-1192	020-1326	021-1439	021-1496	021-1580	021-1682	022-1849
019-1042	020-1193	020-1327	021-1441	021-1497	021-1581	021-1683	022-1850
019-1043	020-1194	020-1328	021-1442	021-1499	021-1585	021-1684	022-1851
019-1044	020-1196	020-1329	021-1443	021-1500	021-1586	021-1685	022-1852
019-1045	020-1197	020-1330	021-1444	021-1501	021-1587	021-1686	022-1853
019-1046	020-1198	020-1331	021-1445	021-1502	021-1588	021-1688	022-1854
019-1054	020-1199	020-1332	021-1446	021-1503	021-1589	021-1689	022-1855
019-1058	020-1200	020-1336	021-1447	021-1504	021-1593	021-1690	022-1856
019-1059	020-1201	020-1337	021-1449	021-1505	021-1594	021-1691	022-1859
019-1060	020-1202	020-1338	021-1450	021-1507	021-1595	021-1692	022-1860
019-1061	020-1204	020-1339	021-1451	021-1514	021-1599	021-1694	022-1861
019-1062	020-1205	020-1340	021-1452	021-1515	021-1600	021-1695	022-1862
019-1063	020-1206	020-1341	021-1453	021-1516	021-1601	021-1696	022-1863
019-1064	020-1207	020-1343	021-1454	021-1517	021-1605	021-1697	022-1864
019-1065	020-1208	020-1368	021-1455	021-1518	021-1606	021-1698	022-1866
019-1066	020-1209	020-1369	021-1458	021-1520	021-1607	021-1794	022-1867
019-1067	020-1210	020-1370	021-1459	021-1521	021-1611	021-1795	022-1868

PART NUMBERS COVERED IN THIS MANUAL

022-1869	FS170DL-3X	FS185-FD-S/M	FS281-L/XL	FS77635-OD-PAD	FS-FLEX270-L
022-1870	FS170DL-4X	FS185-FD-XS	FS281-S/M	FS77635-OD-S/M	FS-FLEX270-M
022-1871	FS170DL-L	FS185-L/XL	FS281-XS	FS9000-COS	FS-FLEX270-S
022-1872	FS170DL-M	FS185-PL-2XL	FS285-2X	FS99160-E-2X	FS-FLEX270-XL
022-1874	FS170DL-S	FS185-PL-L/XL	FS285-3X	FS99160-EFD-2X	FS-FLEX270-XS
022-1875	FS170DL-XL	FS185-PL-S/M	FS285-4X	FS99160-EFD-L	FS-FLEX280-2X
022-1876	FS170DL-XS	FS185-QC-2X	FS285DL-2X	FS99160-EFD-M	FS-FLEX280-3X
022-1877	FS170-L	FS185-QC-3X	FS285DL-3X	FS99160-EFD-S	FS-FLEX280-FD-2X
022-1878	FS170-M	FS185-QC-L/XL	FS285DL-UNI	FS99160-EFD-XL	FS-FLEX280-FD-3X
022-1879	FS170-QC-2X	FS185-QC-S/M	FS285-L/XL	FS99160-E-L	FS-FLEX280-FD-L/XL
022-1880	FS170-QC-3X	FS185-QC-XS	FS285-QC-2X	FS99160-E-M	FS-FLEX280-FD-S/M
022-1881	FS170-QC-L	FS185-R-2X	FS285-QC-3X	FS99160-E-S	FS-FLEX280-FD-XS
022-1882	FS170-QC-M	FS185-R-3X	FS285-QC-L/XL	FS99160-E-XL	FS-FLEX280-L/XL
FS160-2X	FS170-QC-S	FS185-R-L/XL	FS285-QC-S/M	FS99185-E	FS-FLEX280-S/M
FS160-3X	FS170-QC-XL	FS185-R-S/M	FS285-QC-XS	FS99185-E-2XL	FS-FLEX280-XS
FS160-4X	FS170-QC-XS	FS185-R-XS	FS285-S/M	FS99185-EFD	FS-FLEX285-2X
FS160-BC-2XL	FS170-S	FS185-S/M	FS285-XS	FS99185-E-PRECISION	FS-FLEX285-3X
FS160-BC-L	FS170-SAFELINK-2X	FS185-SAFELINK-2XL	FS377-2X	FS99185-E-QC	FS-FLEX285-4X
FS160-BC-M	FS170-SAFELINK-3X	FS185-SAFELINK-L/XL	FS377-L	FS99185-E-QC-2X	FS-FLEX285-L/XL
FS160-BC-S	FS170-SAFELINK-4X	FS185-SAFELINK-S/M	FS377-M	FS99280-E	FS-FLEX285-QC-2X
FS160-BC-XL	FS170-SAFELINK-L	FS185-UNI	FS377-S	FS99281-E	FS-FLEX285-QC-3X
FS160DL-2X	FS170-SAFELINK-M	FS185-XS	FS377-XL	FS99281-EFD	FS-FLEX285-QC-L/XL
FS160DL-3X	FS170-SAFELINK-S	FS2011-2X	FS77325-FR-2X	FS99281-EFD-X	FS-FLEX285-QC-S/M
FS160DL-4X	FS170-SAFELINK-XL	FS2011-3X	FS77325-FR-3X	FS99285-E	FS-FLEX285-QC-XS
FS160DL-L	FS170-XL	FS2011-L	FS77325-FR-4X	FS99285-EFD	FS-FLEX285-S/M
FS160DL-M	FS170-XS	FS2011-M	FS77325-FR-L	FSBELT-2D-RINGS-2X	FS-FLEX285-XS
FS160DL-S	FS185-2X	FS2011-S	FS77325-FR-M	FSBELT-2D-RINGS-L	FS-FLEX360-2X
FS160DL-XL	FS185-2X-PRECISION	FS2011-XL	FS77325-FR-S	FSBELT-2D-RINGS-M	FS-FLEX360-3X
FS160DL-XS	FS185-3X	FS227-2X	FS77325-FR-XL	FSBELT-2D-RINGS-S	FS-FLEX360-4X
FS160-L	FS185-4X	FS227-L/XL	FS77326-FR-2X	FSBELT-2D-RINGS-XL	FS-FLEX360-CECO-2XL
FS160-M	FS185-BR-2XL	FS227-S/M	FS77326-FR-3X	FS-FLEX127-CSE-L	FS-FLEX360-CECO-L
FS160-QC-2X	FS185-BR-L/XL	FS227T-2X	FS77326-FR-4X	FS-FLEX185-2X	FS-FLEX360-CECO-M
FS160-QC-L	FS185-BR-S/M	FS227T-L/XL	FS77326-FR-L	FS-FLEX185-3X	FS-FLEX360-CECO-S
FS160-QC-M	FS185-CECO-2XL	FS227T-S/M	FS77326-FR-M	FS-FLEX185-L/XL	FS-FLEX360-CECO-XL
FS160-QC-S	FS185-CECO-L/XL	FS280-2X	FS77326-FR-S	FS-FLEX185-S/M	FS-FLEX360-FD-2X
FS160-QC-XL	FS185-CECO-S/M	FS280-3X	FS77326-FR-XL	FS-FLEX185-XS	FS-FLEX360-FD-3X
FS160-S	FS185DL-2X	FS280DL-2X	FS77425-WE-2X	FS-FLEX251-2XL	FS-FLEX360-FD-L
FS160-XL	FS185DL-3X	FS280DL-3X	FS77425-WE-3X	FS-FLEX251-L/XL	FS-FLEX360-FD-M
FS160-XS	FS185DL-FD-2X	FS280DL-L/XL	FS77425-WE-4X	FS-FLEX251-S/M	FS-FLEX360-FD-S
FS170-2X	FS185DL-FD-3X	FS280DL-S/M	FS77425-WE-L/XL	FS-FLEX253-CE-2XL	FS-FLEX360-FD-XL
FS170-3X	FS185DL-FD-L/XL	FS280DL-XS	FS77425-WE-S/M	FS-FLEX253-CE-3X	FS-FLEX360-FD-XS
FS170-4X	FS185DL-FD-S/M	FS280-L/XL	FS77425-X-WE-L/XL	FS-FLEX253-CE-L	FS-FLEX360-L
FS170-CECO-2XL	FS185DL-FD-XS	FS280-QC-2X	FS77425-X-WE-S/M	FS-FLEX253-CE-M	FS-FLEX360-M
FS170-CECO-3X	FS185DL-L/XL	FS280-QC-3X	FS77426-WE-2X	FS-FLEX253-CE-S	FS-FLEX360-S
FS170-CECO-L	FS185DL-S/M	FS280-QC-L/XL	FS77426-WE-3X	FS-FLEX253-CE-XL	FS-FLEX360-SL-2XL
FS170-CECO-M	FS185DL-XS	FS280-QC-S/M	FS77426-WE-4X	FS-FLEX253-FD-2XL	FS-FLEX360-SL-L
FS170-CECO-S	FS185-FD-2X	FS280-S/M	FS77426-WE-L/XL	FS-FLEX253-FD-3X	FS-FLEX360-SL-M
FS170-CECO-XL	FS185-FD-3X	FS280-XS	FS77426-WE-S/M	FS-FLEX270-2X	FS-FLEX360-SL-S
FS170-CECO-XS	FS185-FD-4X	FS281-2X	FS77426-WE-XS	FS-FLEX270-3X	FS-FLEX360-SL-XL
FS170DL-2X	FS185-FD-L/XL	FS281-3X	FS77635-OD-L/XL	FS-FLEX270-4X	FS-FLEX360-XL

PART NUMBERS COVERED IN THIS MANUAL

FS-FLEX360-XS	SW-62160-2XL				
FS-HIVIS185-2X	SW-62160-L				
FS-HIVIS185-L/XL	SW-62160-M				
FS-HIVIS185-S/M	SW-62160-S				
FS-RTZ170-L	SW-62160-XL				
FS-RTZ170-M	SW-6510-VI-2XL				
FS-RTZ170-S	SW-6510-VI-L/XL				
FS-RTZ170-XL	SW-6510-VI-S/M				
SW160-QC-2X	SW-6511-VI-2XL				
SW160-QC-3X	SW-6511-VI-L/XL				
SW160-QC-L	SW-6511-VI-S/M				
SW160-QC-M	SW99280-E-US				
SW160-QC-S	SW99280-HW				
SW160-QC-XL	SW99281-E-US				
SW160-QC-XS	SW99281-HW				
SW170-QC-2X	TH40076				
SW170-QC-3X	TH40078				
SW170-QC-4X	TH40080				
SW170-QC-L	TH40081				
SW170-QC-M					
SW170-QC-S					
SW170-QC-XL					
SW170-QC-XS					
SW280-QC-2X					
SW280-QC-3X					
SW280-QC-4X					
SW280-QC-L/XL					
SW280-QC-S/M					
SW280-QC-XS					
SW-5210-2XL					
SW-5210-L/XL					
SW-5210-S/M					
SW-5211-2XL					
SW-5211-3X					
SW-5211-FD-2XL					
SW-5211-FD-L/XL					
SW-5211-FD-S/M					
SW-5211-L/XL					
SW-5211-S/M					
SW-52160-2XL					
SW-52160-L					
SW-52160-M					
SW-52160-S					
SW-52160-XL					
SW-6210-M/L					
SW-6210-S					
SW-6210-XL-2XL					
SW-6211-M/L					
SW-6211-S					
SW-6211-XL/2XL					



Safewaze
225 Wilshire Ave SW
Concord, NC 28025

PHONE: 1-800-230-0319
FAX: 1-704-262-9051

WEB: Safewaze.com
EMAIL: info@Safewaze.com