



'Whatever It Takes'

Operator's Manual

CC3500J Concrete Saw
Part Number: 1802696

(800) 321-5336

www.diamondproducts.com

Table of Contents

Safety Precautions.....	1	Cutting Guides.....	17
Safety Alerts.....	1	Adjusting the Front Pointer	17
Proposition 65	1	Adjusting the Rear Pointer(s).....	18
Spark Arrester Requirement	1	Concrete Cutting.....	18
Respiratory Hazards	1	Helpful Hints Prior to Cutting	18
General Safety	2	Tasks Prior to Cutting	18
Battery and Electrical Safety.....	2	Making a Cut	18
Blade Safety.....	3	Making a Cut Using the Blade Depth Stop	19
Blade Guard Safety.....	3	Continuing a Partial-Cut.....	19
Fuel Safety.....	3	Finishing a Cut.....	19
Engine Safety.....	3	Maintaining the CC3500J	21
Cutting Safety	4	Maintenance Overview	21
Hydraulic Safety.....	4	Daily	21
Belt Safety.....	4	40 Hours	21
Transporting Safety.....	4	100 Hours.....	21
Lifting Safety	5	250 Hours.....	21
Introducing the CC3500J	7	Part Lubrication	21
Components.....	7	Inner Blade Flange	21
Controls.....	8	Installing the Inner Blade Flange	21
Dimensions	9	Removing the Inner Blade Flange	21
Specifications.....	10	Drive Alignment	21
Operating the CC3500J	11	Wheels.....	22
Spotlight (Optional)	11	Replacing the Front Wheels	22
Standard Spotlight	11	Replacing the Rear Wheels.....	22
Magnetic Spotlight	11	Battery	23
Handlebars.....	11	Battery Type	23
Adjusting the Handlebars.....	11	Servicing the Battery	23
Control Grip Pushbuttons	11	Speed Control Lever.....	23
Blade Lowering Speed (Optional).....	11	Adjusting the Speed Control Lever Linkage.....	23
Fuel System.....	12	Adjusting the Speed Control Lever Friction	23
Adding Fuel.....	12	Magnetic Sensor (Optional).....	24
Blade Guard.....	12	Adjusting the Magnetic Sensor	24
Installing the Blade Guard.....	12	Replacing the Magnetic Sensor.....	24
Removing the Blade Guard.....	13	Electrical System	24
Flange Guard	13	Transmission	24
Installing the Flange Guard.....	13	Cooling Fan	24
Removing the Flange Guard.....	13	Adding Fluid.....	24
Diamond Blades.....	13	Tightening the Rear Drive Chain	24
Inspecting the Blade	13	Hydraulic System.....	25
Blade Speed	13	Adding Fluid to the Hydraulic Lift Pump.....	25
Wrench	13	Belt Sheaves	25
Installing the Blade.....	14	Changing the Belt Sheaves	25
Removing the Blade.....	15	Aligning the Belt Sheaves.....	26
Engine	15	Belt System	26
Vernier Throttle	15	Tensioning/Replacing the Blade Drive Belts.....	26
Tasks Prior to Starting the Engine	16	Tensioning/Replacing the Jackshaft Belts	27
Starting the Engine	16	Replacing the Transmission Drive Belt.....	27
Stopping the Engine.....	16	In-Line Fuel Filter.....	27
Transmission Lever.....	16	Engine	28
Engaging the Transmission	16	Cleaning the Engine	28
Disengaging the Transmission.....	16	Storing	28
Speed Control Lever	16	Disposal.....	28
Water Supply	17	References	29
Using the Water Supply	17	Appendix A	29
		Serial Tags	29

Appendix B.....	30
Daily Maintenance Task Chart.....	30
Appendix C	31
Belt Tension Settings	31
Appendix D	32
Troubleshooting	32
Appendix E.....	33
Additional Resources	33

Safety Precautions

Operate the CC3500J Concrete Saw and all of its components according to this manual. Failure to comply with and understand the following safety, operations, and maintenance instructions can result in serious injuries and/or death. All operators must be properly trained or supervised by experienced personnel prior to using this saw and should understand the risks and hazards involved. Diamond Products discourages improper or unintended saw usage and cannot be held liable for any resulting damages.

Saw modifications should be made by Diamond Products to ensure safety and design. Any modifications made by the owner(s) are not the responsibility of Diamond Products and void all saw warranties if a problem arises as a result of the modification.

Refer to the CC3500J Parts List for additional information and part diagrams. Refer to the engine manual and manufacturer as the primary source for all safety, operations, and maintenance instructions regarding the engine. Prior to operating, record the saw's serial number, and the engine's model and serial numbers in Appendix A.

Notice: The information in this manual may be updated at any time!

Safety Alerts

DANGER

Serious injuries and/or death will occur if these instructions are not followed.

WARNING

Serious injuries and/or death could occur if these instructions are not followed.

CAUTION

Mild and/or moderate injuries could occur if these instructions are not followed.

Proposition 65

WARNING

Engine exhaust and some of its constituents are known to the State of California to cause cancer, birth defects, and/or other reproductive harm.



Spark Arrester Requirement

WARNING

In the State of California it is a violation of section 4442 or 4443 to use or operate the engine on any forest-covered, brush-covered, or grass-covered land unless the engine is equipped with a spark arrester, as defined in section 4442, maintained in effective, working order or the engine is constructed, equipped, and maintained for the prevention of fire pursuant to section 4443.

Respiratory Hazards

WARNING

Concrete cutting produces dust and fumes known to cause illness, death, cancer, respiratory disease, birth defects, and/or other reproductive harm. Safety protection techniques include, but are not limited to:

- Wearing gloves.
- Wearing safety goggles or a face shield.
- Using approved respirators.
- Washing work clothes daily.
- Using water when wet cutting to minimize dust.
- Washing the hands and face prior to eating/drinking.

For additional safety and self-protection information contact your employer, the Occupational Safety and Health Administration (OSHA), and/or The National Institute for Occupational Safety and Health (NIOSH).

General Safety

- Read and understand all safety, operations, and maintenance instructions provided in this manual prior to operating or servicing the saw.
- Keep saw components clean and free of slurry, concrete dust, and debris.
- Inspect water hoses prior to operating the saw. Clean, repair, or replace damaged components.
- Raise the saw to a proper height for access when working underneath the saw. Use chocks to block the wheels, and fit blocks or jacks under the frame edges at the front and back of the frame for additional support.
- When using a jack to raise the saw, place the jack against a solid, flat area under the frame base to properly support the saw.
- Repair the saw immediately when a problem arises.
- Replace saw decals if unreadable.
- Dispose of all hazardous waste materials according to city, state, and federal regulations.
- Always have a phone nearby, and locate the nearest fire extinguisher and first aid kit prior to operating the saw.
- Operate the saw wearing flame resistant clothing.
- Always wear safety glasses when removing retaining rings.
- Persons under the statutory age limit should not operate the saw.
- Keep all body parts away from rotating machinery.
- Replace all guards and access panels (unless stated otherwise) prior to operating the saw.
- Always pivot guards fully to avoid serious injuries.
- DO NOT assume the saw will remain still when in neutral or when parking/stopping the saw on a slope. Chock the wheels to help prevent unnecessary movement.

DO NOT:

- Drop equipment, supplies, tools, etc., when handling to help prevent injuries.
- Lift and carry equipment, supplies, tools, etc., that are too heavy and/or cannot be lifted easily.
- Operate the saw without using the appropriate safety equipment required for the work task.



- Operate or service the saw with any clothing, hair, or accessories that can snag in the machinery, which could lead to serious injuries or death!
- Operate the saw using attachments not associated with or recommended for the saw.

DO NOT (cont.):

- Operate the saw around combustible materials or fumes to prevent fires/explosions.
- Operate the saw with anyone near the work area or within the direct line of the blade.
- Operate the saw until all unnecessary materials have been removed from the work area.
- Operate the saw with loose nuts, screws, and bolts.
- Operate the saw when ill or fatigued.
- Operate the saw under the influence of drugs and/or alcohol.
- Operate the saw on steep slopes.
- Cut concrete with guards and access panels removed.
- Grease the saw with the engine running (unless stated otherwise).
- Touch hot components when operating the saw.
- Leave the saw unattended until the engine is off and the blade has stopped spinning.
- Place the saw into storage until it has cooled down.
- Service the saw until it has cooled down.
- Service the saw with the engine running (unless stated otherwise).

Battery and Electrical Safety

- Ignitable explosive gases are emitted from the battery. DO NOT expose the battery to sparks or open flames. 
- Keep the area around the battery well-ventilated.
- Keep the battery level when handling it.
- Use protective eyewear or a face shield, and avoid contact with the skin when handling/servicing the battery.
- Use a proper battery tester when testing the battery strength.
- Always be sure to connect the battery cables to the proper terminal when reconnecting the cables.
- Occasionally inspect the battery, cables, clamps, and terminals for damages. Service components as necessary.
- Always keep the battery cable clamps away from the battery terminals when the battery is disconnected to avoid accidental connections while servicing.
- Immediately rinse your clothing, skin, or eyes with water if exposed to battery acid. Seek medical attention immediately!
- Disconnect the battery prior to servicing all saw components (unless stated otherwise).
- Remove the battery when storing the saw for longer periods.
- Always use the correct size fuses (amps) to prevent fires.

Blade Safety

- Always use reinforced abrasive blades or steel-centered diamond blades.
 - Never use a wet cutting blade without an adequate water supply to properly lubricate the blade.
 - Inspect all blades prior to usage and discard damaged blades. Clean dirty blades as necessary.
 - DO NOT install or remove a blade with the engine running.
 - Keep all body parts away from rotating blades.
 - Inspect the blade flanges for damages, wear, and cleanliness. Clean or replace dirty/damaged components immediately.
-
- DO NOT expose yourself or anyone else to the direct line of the blade when operating the saw. 
-
- Always use an appropriate size blade and the correct blade type based on the cutting task and the type of material being cut.
 - The blade must always fit snug on the blade shaft, outer flange, and/or inner flange.
 - Wear gloves and be alert to the surrounding environment when handling blades.
 - When installing the blade, always point the arrow printed on the blade in the direction of the blade shaft's rotation.
 - DO NOT exceed the blade's maximum recommended speed when cutting. Excessive blade speeds can cause blade breakage, resulting in serious injuries and/or death!
 - DO NOT use damaged blades when cutting to avoid harming yourself, others, or the saw.
 - DO NOT use a blade for cutting that requires a lower speed than the blade shaft speed.
 - Always tighten the blade shaft bolt/screw as directed to properly secure the outer flange and blade. Failure to properly secure the outer flange and blade may cause parts to loosen or fall off the saw, resulting in serious injuries or death!
 - Let the blade cool prior to removal when dry cutting (applicable models).

Blade Guard Safety

- DO NOT operate the saw with the blade guard raised or removed.
- Blade exposure should not exceed 180° while cutting.
- When pivoting the front of the blade guard, raise/lower it cautiously and slowly to avoid serious injuries.
- DO NOT pivot the blade guard front up or down when installing/removing very large blades. Attempting to pivot the front of a heavy guard when

the guard is positioned higher up for blade installation/removal makes the guard difficult to lift and/or lower. In this situation, install/remove the blade guard front instead of pivoting it.



- Always pivot the front of the blade guard 180° (fully upward) so the guard does not swing down unexpectedly, causing serious injuries. 
- Always secure the pivoted section of the blade guard using the detent pin (guards 26" and up).
- Use extreme caution when installing/removing parts of a guard or the entire guard as guards can be extremely heavy and may require installation/removal at moderate heights.
- DO NOT install or remove the blade guard with the engine running.
- Always use a blade guard that corresponds with the blade size.
- Inspect the blade guard and water tubes prior to starting the saw. Clean or replace dirty/damaged components immediately.

Fuel Safety

- Always use caution when refueling.
 - Store all fuel in appropriate safety containers.
 - DO NOT operate the saw with a fuel leak.
 - DO NOT fuel the saw with the engine running.
 - Let the engine cool prior to adding fuel.
 - Refer to the engine manual for recommended fuels.
 - Always use appropriate fuels in cold weather.
 - Move the saw away from the refueling area prior to starting the engine.
-
- DO NOT smoke or expose fuel to open flames when filling the fuel tank or working with fuel. 
 - Clean up any spilled fuel prior to starting the engine.
 - Drain the fuel tank and fuel lines when storing the saw for longer periods of time. Refer to the engine manual for additional recommendations.

Engine Safety

- Refer to the engine manual as the primary source for engine safety.
- Always know how to turn off the engine quickly for emergency purposes.
- Make sure the saw is in neutral when starting the engine.
- Fill the fuel tank and check the oil level prior to starting the engine.

-
- Keep all body parts away from rotating saw parts with the engine running. 
 - DO NOT start the engine without the air filter(s) installed.
 - DO NOT allow dust to enter the air intake tube when cleaning/replacing air filter(s).
 - Replace damaged components immediately that may allow dust to enter the engine.
 - DO NOT leave the engine running unattended.
-
- Always operate the saw in well-ventilated areas. Concentrated engine exhaust can cause loss of consciousness and/or death. 
 - DO NOT touch the engine/muffler assembly with the engine running, and always let them cool down prior to touching or servicing the saw.
 - Handle hot oil carefully when changing the oil.
 - Let the engine cool prior to removing pressurized caps (applicable models).
 - DO NOT use any starter substances or starter fluids (e.g., starter fluid sprayed into the air filter) when starting the engine using a glow plug (applicable models). These materials are extremely flammable and explosive, and can melt parts or possibly explode when used to help start the engine.

Cutting Safety

- The direct work area should not contain buried or embedded electrical, gas, or water lines that could be damaged and/or cause personal injury while cutting.
- Turn off all electricity, gas, and water around the direct work area prior to cutting.
- DO NOT expose yourself or anyone else to the direct line of the blade when operating the saw.
- DO NOT allow any person, animal, and/or object in and around the work area while cutting.

Hydraulic Safety

- Turn off the engine prior to servicing hydraulic components.
- Lower the saw completely prior to servicing to decrease the hydraulic pressure in the lines.
- Always make sure any hydraulic components being serviced are not supporting the weight of other saw components. If a particular component is under pressure when connection points are loosened, oil may spray out forcefully.

-
- Always place a piece of cardboard or paper up against hydraulic components, or use a leak detection fluid to check for hydraulic fluid leaks. Keep all body parts away from leaks and/or areas that may eject hydraulic fluid. Pressurized hydraulic fluid can penetrate the skin, causing serious injuries. Seek medical attention immediately! 
-

Belt Safety

- Turn off the engine and let the belts cool down prior to servicing them.
- Regularly inspect the belts for fraying, stress cracks, and/or breakage and replace immediately when damaged. Always check the belt alignment prior to operating the saw.
- Use extreme caution when working with belts and rotating machine parts to avoid entanglement.
- Over-tensioning belts may damage the crankshaft. Under-tensioning belts may cause slippage, shorter belt life, and/or poor saw performance.
- Squealing belts indicate looseness.
- DO NOT use old and new belts together on the same sheave.

Transporting Safety

- Remove the blade prior to transporting the saw.
 - Make sure the truck/trailer is in good, working condition and sufficient to transport the load. DO NOT tow the saw behind a vehicle.
 - Close the fuel shutoff valve (applicable models) when transporting.
 - Drain the fuel tank when transporting long distances.
 - Use heavy-duty ramps that will support the weight of the saw and yourself when loading or unloading.
 - Raise the saw to avoid damaging components while moving up and down ramps.
-
- Use extreme caution when guiding the saw up and down ramps. Slowly drive the saw forward down the ramp. Slowly back the saw in reverse up the ramp. Avoid standing directly downhill from the saw to prevent machine rollover. 
-
- Place the saw in neutral and turn off the engine once the saw is loaded in the truck/trailer.
 - Chock the wheels and secure the saw in the truck/trailer prior to transporting.
 - Refer to the Department of Transportation (DOT) for additional transportation recommendations.

Lifting Safety

- Move yourself and all others away from the lifting area when hoisting the saw to prevent being crushed.
- Secure the appropriate hoisting cables, straps, and/or chains to the saw's designated lift points prior to hoisting.
- Never use the tie-down brackets (applicable models) to lift the saw.
- DO NOT attempt to lift the saw irresponsibly and/or improperly.



Introducing the CC3500J

Components

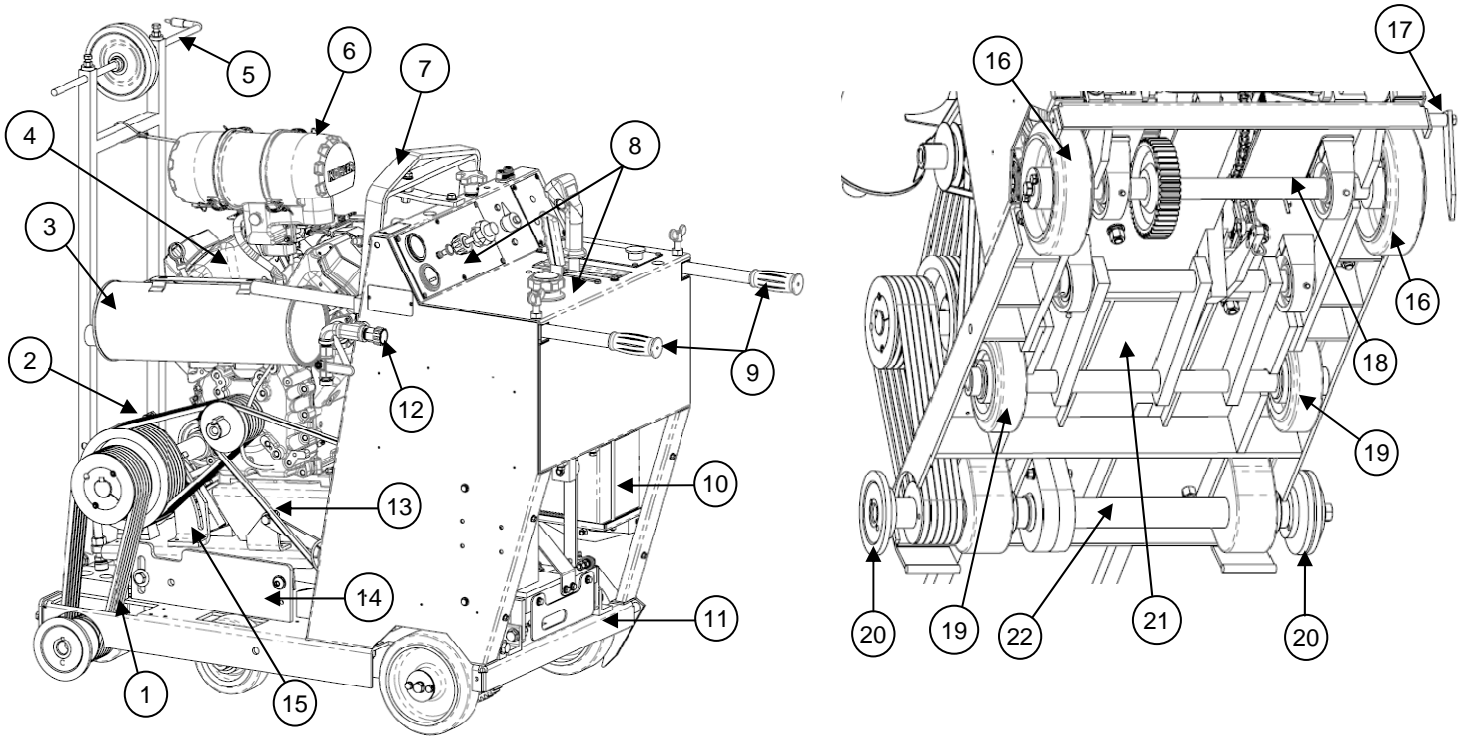

Figure 1: CC3500J Components

- | | |
|-----------------------------------|---|
| 1. Blade Shaft to Jackshaft Belts | 12. Water Valve Lever and Hose Fittings |
| 2. Jackshaft to Engine Belts | 13. Transmission Belt |
| 3. Muffler | 14. Engine Mount |
| 4. Engine | 15. Jackshaft Mount |
| 5. Front Pointer | 16. Rear Wheels |
| 6. Air Cleaner | 17. Rear Pointer |
| 7. Frame Lift | 18. Rear Axle |
| 8. Control Panel | 19. Front Wheels |
| 9. Handlebars | 20. Blade Flanges |
| 10. Battery | 21. Front Axle |
| 11. Frame Base | 22. Blade Shaft |

Controls

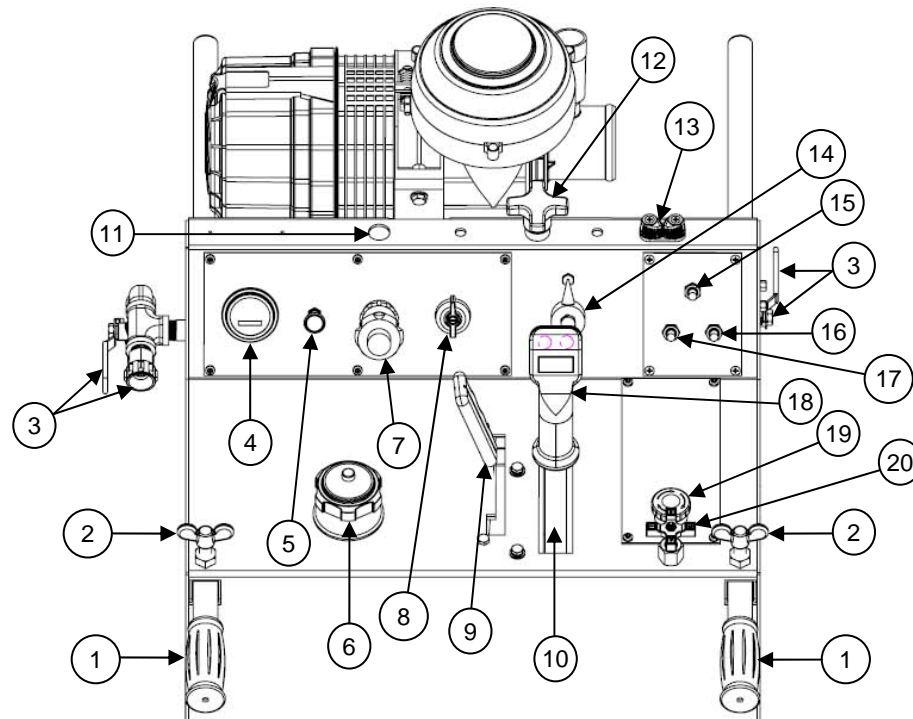

Figure 2: CC3500J Controls

1. **Handlebars**—Helps guide and maneuver the saw.
 2. **Handlebar Lock Knob**—Locks handlebar in position.
 3. **Water Valve Lever and Hose Fitting**—Lever controls water flow to blade; hose fitting connects to water source hose or water supply hose.
 4. **Hour Meter**—Indicates total number of saw hours operated.
 5. **Choke**—Restricts air flow in carburetor when starting a cold engine.
 6. **Fuel Tank Cap**—Fuel port; indicates fuel level.
 7. **Vernier Throttle**—Increases or decreases engine speed.
 8. **Ignition Switch**—Three-position switch stops the engine, provides power to accessories, or starts the engine.
 9. **Transmission Lever**—Engages or disengages the transmission.
 10. **Speed Control Lever**—Forward, stop (neutral), and reverse control for the saw.
 11. **Magnetic Spotlight Outlet (optional)**—Power outlet for magnetic spotlight.
 12. **Depth Stop Knob**—Sets blade cutting depth; increases and decreases cutting depth.
 13. **Cable Cleat**—Secures front pointer rope.
 14. **Cutting Depth Indicator**—Indicates blade's depth from surface.
 15. **Water Safety Switch (optional)**—Indicates low water pressure to the blade. *Note: The switch does not detect flow.*
 16. **Spotlight Switch (optional)**—Activates spotlight.
 17. **Water Pump Switch (optional)**—Activates water pump.
 18. **Control Grip**—Pushbuttons on back of grip raise or lower the saw and blade.
 19. **Emergency Stop Button**—Stops the engine.
 20. **Blade Lowering Speed Valve (optional)**—Adjusts saw's lowering speed.
- Items Not Shown Above:*
1. **Blade Tachometer (optional)**—Indicates blade speed.
 2. **Parking Brake Lever (optional)**—Engages or disengages the parking brake.
 3. **Spotlight**—Light source.

Dimensions

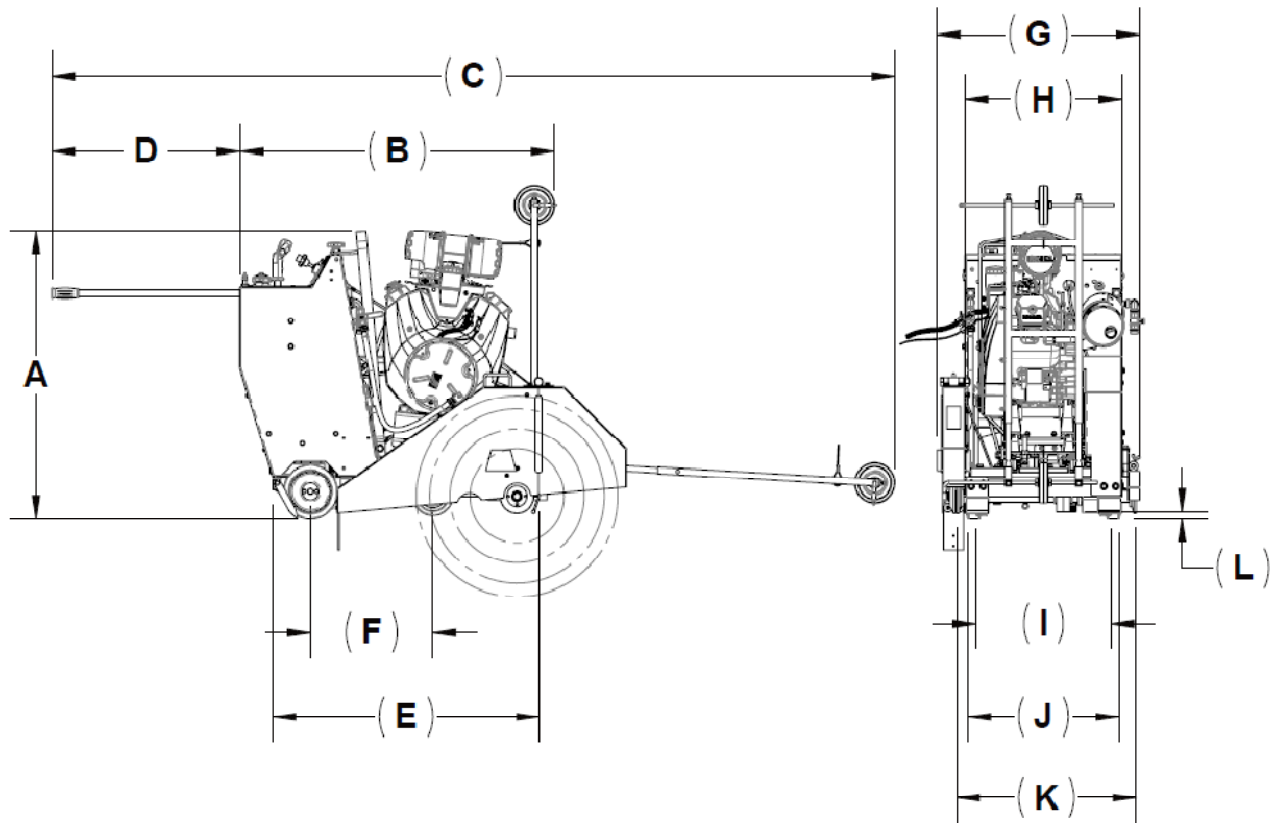

Figure 3: CC3500J Dimensions

Table 1: CC3500J Dimensions		
A	Saw Height	43"
B	Minimum Saw Length	46-3/4"
C	Maximum Saw Length	125-1/2"
D	Maximum Handle Extension	28"
E	Frame Length	39-3/4"
F	Wheel Base Length	18-1/4"
G	Saw Width	30-1/4"
H	Frame Width	23-1/2"
I	Front Wheels Inside Width	20-1/4"
J	Rear Wheels Outside Width	22-1/2"
K	Inner Flange to Inner Flange Width	26-3/4"
L	Ground Clearance (Saw Level)	1"
L	Ground Clearance (Saw Raised)	3/4"
	Maximum Blade Shaft Height (not shown above)	17"
Crated Dimensions		36" x 66" x 52"

Specifications

Table 2: CC3500J Specifications	
Maximum Cutting Depth	12-3/8" with 30" blade
Blade Shaft Diameter	1-3/4"
Arbor Diameter	1" with single drive pin
Blade Shaft Bearings	Rexnord, 1-3/4" bore, mounted roller bearings
Blade Shaft Drive	Matched set of 6 V-belts
Jackshaft Belt Drive	Matched set of 6 V-belts
Blade Mounting	Right or left
Blade Raise/Lower	Electro-hydraulic pump
Blade Coolant	Dual multi-spray tubes
Blade Guard Attachment	Slip-on up to 26", brace for 30"
Handlebars	Length and tilt adjustable
Drive Speed	0-200 ft/min
Front Wheels	6" x 2"
Rear Wheels	8" x 2-1/2"
Transmission	Eaton hydrostatic
Uncrated Weight <i>(add 70 lb for crated weight)</i>	1,060 lb <i>(actual weight depends on model and added options)</i>

Table 3: Engine Specifications		
Manufacturer	Briggs & Stratton	Kohler
Model	540000 Vanguard	CH1000
Fuel Capacity	Six gallons	Six gallons
Fuel Type	Unleaded gasoline – minimum 85 octane	Unleaded gasoline- minimum 87 octane
Air Filter	Four-stage with restriction indicator	Heavy-duty style
<i>Note: Refer to the engine manual and manufacturer for additional engine information and specifications.</i>		

Operating the CC3500J

For additional information and detailed diagrams on individual saw components, refer to the CC3500J Parts List in conjunction with this manual.

Spotlight (Optional)

Standard Spotlight

1. Loosen both spotlight bar lock knobs and slide the spotlight bar from side-to-side to adjust the length of the bar.
2. Tighten the lock knobs to secure.
3. Turn the spotlight switch on or off as needed for additional lighting.

Magnetic Spotlight

1. Secure the magnetic spotlight base to either side of the frame upright.
2. Plug the spotlight into the power outlet on the frame upright.
3. Turn the spotlight switch on or off as needed for additional lighting.

Handlebars

The handlebars help guide and maneuver the saw. Place the handlebars in the desired position for better leverage when lifting and steering.

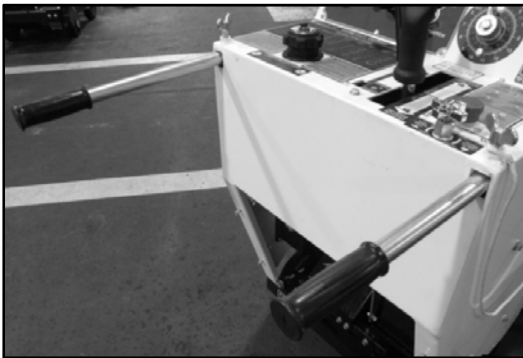

Figure 4: Handlebars

Adjusting the Handlebars

1. Loosen the handlebar lock knob.
2. The handlebar can be positioned on an angle or straight on. To change the position, pull the handlebar out until it reaches the frame opening. Push it back into the frame and guide the bar into the angled or straight on pathway inside the frame upright.

3. Move the handlebar forward or backward to adjust the length of the handlebar, and retighten the lock knob to secure.

Control Grip Pushbuttons

The control grip pushbuttons raise and lower the saw and blade (buttons work with engine off).



Figure 5: Control Grip Pushbuttons

1. Press the *Raise* (left) pushbutton to raise the saw and blade, and release to stop. *Note: Always raise the blade when maneuvering the saw to provide proper clearance between the blade and the ground.*
2. Press the *Lower* (right) pushbutton to lower the saw and blade, and release to stop.

Blade Lowering Speed (Optional)

Turn the *Blade Lowering Speed* valve counterclockwise to increase the blade's lowering speed and clockwise to decrease the blade's lowering speed. *Note: The valve does not adjust the blade's raising speed.*



Figure 6: Blade Lowering Speed Valve

Fuel System

WARNING

- Always use caution when refueling.
- DO NOT operate the saw with a fuel leak.
- DO NOT fuel the saw with the engine running.
- DO NOT smoke or expose fuel to open flames when filling the fuel tank or working with fuel.



CAUTION

- Clean up any spilled fuel prior to starting the engine.
- Fuel may seep out from the fuel cap vent (applicable models) when raising the saw if the fuel tank is overfilled.

Adding Fuel

1. Lower the saw to level the frame.
2. Turn off the engine and let the saw cool down.
3. Remove the fuel tank cap.
4. Fill the fuel tank using unleaded gasoline with a minimum of 85 octane (Briggs & Stratton) or 87 octane (Kohler). DO NOT overfill the tank for expansion purposes. Refer to the engine manual for additional information on appropriate fuels in normal and cold weather temperatures.
5. Replace the fuel tank cap and secure.

Blade Guard

WARNING

- DO NOT operate the saw with the blade guard raised or removed.
- DO NOT remove the blade guard with the engine running.
- Blade exposure should not exceed 180° while cutting.
- Always pivot the front of the blade guard 180° (fully upward) so the guard does not swing down unexpectedly, which may cause serious injuries.
- Always secure the pivoted section of the blade guard using the detent pin (guards 26" and up).
- When pivoting the front of the blade guard, raise/lower it cautiously and slowly to avoid serious injuries.



The blade guard shields the blade and must always be in place when operating the saw. Blade guards generally stay in place at all times, except for when changing to another guard size or when using the guard on the opposite side of the saw. Regularly inspect the blade guard and water tubes. Clean, repair, or replace dirty or damaged components immediately. *Note: Always use a guard size that matches the blade size. Refer to the CC3500J Parts List for additional information.*

Installing the Blade Guard

Always install the blade guard with the blade off the saw.

1. Holding the blade guard handle, face the front of the blade guard forward and fit the tapered mount on the side of the guard onto the tapered mount on either the frame base (right side of saw) or the belt guard (left side of saw).



Figure 7: Frame Base Mount

2. Insert the lock pin through the hole on the tapered mount to secure the guard.
3. For the 30" guard, secure the blade guard brace to the guard (near top of guard) and to the frame base.
4. Connect the water supply hose to the blade guard.

Removing the Blade Guard

Always remove the blade guard with the blade off the saw.

1. Disconnect the water supply hose from the blade guard.
2. For the 30" guard, remove the blade guard brace.
3. Remove the lock pin from the tapered mount.
4. Use the handle on the blade guard to rock the guard back and forth while lifting the guard off the tapered frame base or belt guard mount.

Flange Guard

Install the flange guard over the flange assembly not in use for protection against dust, debris, and slurry. *Note: Secure the blade shaft bolt/screw not in use to the front of the flange guard.*

Installing the Flange Guard

1. Fit the tapered mount on the back of the flange guard onto the tapered mount on either the frame base (right side of saw) or the belt guard (left side of saw).
2. Insert the lock pin through the hole on the tapered mount to secure the guard.

Removing the Flange Guard

1. Remove the lock pin from the tapered mount.
2. Remove the flange guard from the tapered mount.

Diamond Blades

! WARNING

- DO NOT exceed the blade's maximum recommended speed when cutting. Excessive blade speeds can cause blade breakage, resulting in serious injuries and/or death.
- DO NOT use damaged blades when cutting to avoid harming yourself, others, or the saw.



Using the proper blade (size and type) preserves the blade and improves efficiency, resulting in lower costs. Refer to the Association of Equipment Manufacturers (AEM) safety brochure for diamond blades and www.diamondproducts.com for additional blade information.

Inspecting the Blade

Inspect each blade prior to installation and discard all damaged blades. Inspect the blades for:

- Cracks, nicks, and dents
- A damaged/deformed arbor (center hole)
- Darkness/discoloration near edge of blade
- A deformed blade circumference
- Segment loss/cracks
- Core wear
- Bending
- Uneven side-widths

Blade Speed

Refer to the CC3500J RPM Chart, the blade, or the blade packaging information for the recommended blade speeds when cutting. DO NOT exceed the maximum recommended blade speed. DO NOT use a blade for cutting that requires a lower speed than the minimum blade shaft speed.

Wrench

Use the wrench provided when installing or removing a blade. Apply force to the opposite end of the wrench and tighten the blade shaft bolt/screw to 125 ft-lb (169.5 Nm) to secure the outer flange and blade. Verify this measurement with a torque wrench.

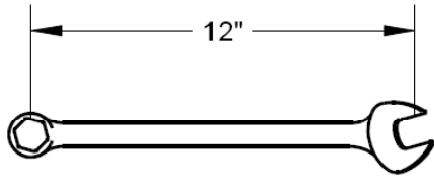

Figure 8: Wrench

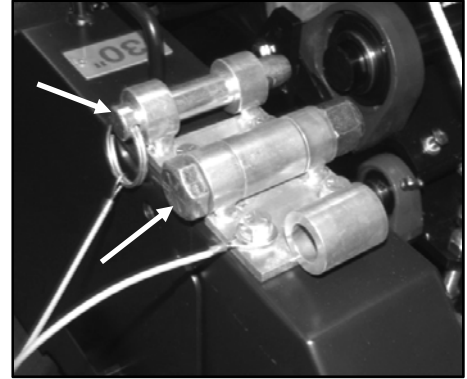

Figure 9: Detent Pin and Hinge Screw

Installing the Blade

! WARNING

- DO NOT install a blade with the engine running.
- Failure to properly secure the outer flange and blade may cause parts to loosen or fall off the saw, resulting in serious injuries or death!
- DO NOT pivot the front of the blade guard up or down when installing very large blades. Attempting to pivot the front of a heavy guard when the guard is positioned higher up for blade installation makes the guard difficult to lift and/or lower. In this situation, remove the blade guard front instead of pivoting it.
- Always secure the pivoted section of the blade guard using the detent pin (guards 26" and up).



! CAUTION

- Wear gloves and be alert to the surrounding environment when handling blades.

The blade can be installed on the right or left side of the saw. Install the blade on the side preferred or most appropriate for the cutting task.

1. Select a blade size and type. Remember to check the blade for damages and discard as necessary. *Note: If changing the blade size, adjust and/or change all necessary saw components according to the information in the CC3500J Parts List.*
2. Remove the detent pin (guards 26" and up) from the guard hinge and pivot the front of the blade guard 180° (fully upward) to gain access to the blade flanges. For larger, heavier guards that are positioned too high up and are unsafe to pivot, remove the lock nut and screw from the center of the guard hinge. Remove the front of the guard. *Note: Have a second trained operator hold the guard in place while removing the hinge screw and nut.*
3. On pivoted guards, insert the detent pin through the interlocking barrels on the top of the guard to secure the front of the guard. *Note: Failure to fully pivot and secure the front of the guard may cause serious injuries.*
4. Remove the blade shaft screw (clockwise loosens on right side, counterclockwise loosens on left side) using the wrench.
5. Carefully remove the outer flange or flange cover plate. Inspect the flange assembly and clean or replace dirty/damaged components. *Note: If removing the cover plate, remove the outer flange from the other side of the saw for use. Secure the cover plate to the inner flange not in use.*
6. Place the blade against the inner flange. For large blades, carefully roll the blade up to the inner flange. Adjust the height of the saw to align the flange and blade arbor. *Note: Point the arrow printed on the blade in the direction of the blade shaft's rotation.*
7. Align and fit the outer flange and flange pin through the blade and into the inner flange and blade shaft. *Note: The outer flange should fit snug with the blade, inner flange, and blade shaft.*
8. Slightly rotate the outer flange and blade backward to eliminate backlash (looseness) between parts.
9. Place the lock washer and then the flat washer onto the blade shaft screw and insert the screw into the blade shaft through the center of the outer flange.
10. Tighten the screw by hand (use left-hand threaded screw on right side of saw only). Slowly lower the saw, if necessary, until the blade just touches the ground.
11. Tighten the screw again, using the wrench, to 125 ft-lb (169.5 Nm) to secure the outer flange and blade. Verify this measurement with a torque wrench.
12. Remove the detent pin (guards 26" and up) from the guard hinge and pivot the front of the guard down over the blade to secure. Reinsert the pin through the double barrel.

13. If replacing the front of the guard, fit the front and back of the blade guard together. Place the screw through the center of the guard hinge and tighten the lock nut to the other end of the hinge screw to secure the guard together. *Note: Have a second trained operator hold the guard in place while replacing the hinge screw and nut.*

Removing the Blade

CAUTION

- DO NOT remove a blade with the engine running.
- DO NOT pivot the front of the blade guard up or down when removing very large blades. Attempting to pivot the front of a heavy guard when the guard is positioned higher up for blade removal makes the guard difficult to lift and/or lower. In this situation, remove the blade guard front instead of pivoting it.
- Always secure the pivoted section of the blade guard using the detent pin (guards 26" and up).



1. Remove the detent pin (guards 26" and up) from the guard hinge and pivot the front of the blade guard 180° (fully upward) to gain access to the blade. For larger, heavier guards that are positioned too high up and are unsafe to pivot, remove the lock nut and screw from the center of the guard hinge. Remove the front of the guard. *Note: Have a second trained operator hold the guard in place while removing the hinge screw and nut.*
2. On pivoted guards, insert the detent pin through the interlocking barrels on the top of the guard to secure the front of the guard. *Note: Failure to fully pivot and secure the front of the guard may cause serious injuries.*
3. Slowly lower the saw, if necessary, until the blade just touches the ground.
4. Remove the blade shaft screw using the wrench.
5. Carefully remove the outer flange and blade. Place the blade in an appropriate storage location. *Note: If the outer flange is difficult to remove, tighten a setscrew into two of the holes on the outside of the outer flange to help separate the outer flange from the blade. Remove the setscrews when separated.*
6. Inspect the flange assembly and clean or replace dirty/damaged components.
7. Carefully fit the outer flange back into the inner flange and/or blade shaft.
8. Place the lock washer and then the flat washer onto the blade shaft screw and insert the screw into the blade shaft through the center of the outer flange.

9. Retighten the blade shaft screw to secure the flanges.
10. Remove the detent pin (guards 26" and up) from the guard hinge and pivot the front of the guard down over the blade flanges to secure. Reinsert the pin through the double barrel.
11. If replacing the front of the guard, fit the front and back of the blade guard together. Place the screw through the center of the guard hinge and tighten the lock nut to the other end of the hinge screw to secure the guard together. *Note: Have a second trained operator hold the guard in place while replacing the hinge screw and nut.*

Engine

WARNING

- Operate the saw in well-ventilated areas. Concentrated engine exhaust can cause loss of consciousness and/or death.
- DO NOT touch the engine/muffler with the engine running, and always let them cool down prior to touching or servicing the saw.
- DO NOT leave the saw unattended while the engine is running.



Vernier Throttle



Figure 10: Vernier Throttle

1. Turn the *Hold/Release* knob counterclockwise to loosen the knob.
2. Turn the throttle counterclockwise to increase the engine speed, or push in the throttle's spring-loaded tip and pull the throttle out to increase the engine speed. Turn the throttle clockwise to decrease the engine speed, or push in the throttle's spring-loaded tip and push the throttle in to decrease the engine speed. *Note: The engine must run at half throttle or greater when maneuvering the saw with power.*

3. Turn the *Hold/Release* knob clockwise to tighten the knob and secure the engine speed.

Tasks Prior to Starting the Engine

Complete the tasks listed below prior to starting the engine to ensure a safe start:

- Check fluids and fill to appropriate levels.
- Place speed control lever at *Neutral*.
- Disengage transmission.
- Turn off controls and switches.
- Remove tools from area.

Notice: The engine will not start with the emergency stop button pushed down. Always pull out the emergency stop button prior to operating the saw.

Starting the Engine

Notice: In an emergency, press the emergency stop button to immediately stop the engine and any saw movement!

1. Open the fuel shutoff valve.
2. Pull out the choke to close the choke.
3. Increase the engine speed to half throttle (Kohler engine) or full throttle (Briggs & Stratton engine).
4. Insert the key into the ignition, turn it to *Start*, and release when the engine starts. Refer to the information in the engine manual when starting the engine in cold weather. *Note: If the engine does not start within 10 seconds, turn off the key and try again approximately 30 seconds later. Refer to Appendix D or the engine manual for troubleshooting recommendations after several failed attempts.*
5. Let the engine warm up for several minutes. Check all warning lights (applicable models) and turn off the engine immediately to fix any problems prior to operating the saw.
6. Push in the choke slowly to open the choke. *Note: When restarting a warm engine, open the choke immediately once the engine starts.*
7. Adjust the engine speed as necessary for maximum efficiency while operating. Refer to the engine manual for additional information.

Stopping the Engine



- DO NOT leave the saw unattended until the engine is off and the blade has stopped spinning.

1. Place the speed control lever at *Neutral* and raise the blade from the cut.
2. Turn off all controls, switches, and water.
3. Decrease the engine speed to idle for five minutes to cool down the engine.
4. Turn the ignition key to *Off* and remove the key.

Transmission Lever

Disengage the transmission prior to starting the engine to prevent unnecessary saw movement. *Note: The engine must run at half throttle or greater for proper transmission efficiency when maneuvering the saw with power.*



Figure 11: Transmission Lever

Engaging the Transmission

1. Place the speed control lever at *Neutral*.
2. Start the engine.
3. Remove the transmission engagement lever from the *Disengage* slot.
4. Push the lever up and place it into the *Engage* slot.

Disengaging the Transmission

1. Place the speed control lever at *Neutral*.
2. Remove the transmission engagement lever from the *Engage* slot.
3. Pull the lever down and place it into the *Disengage* slot.

Speed Control Lever

The speed control lever moves the saw forward and backward at up to 200 ft/min. *Note: The engine must be running at half throttle or greater to move the saw using the speed control lever.*



Figure 12: Speed Control Lever

1. Slowly push the lever toward *Forward* to move the saw forward and release when at the desired traveling speed.
2. Slowly pull the lever toward *Reverse* to move the saw backward and release when at the desired traveling speed.
3. Place the lever at *Neutral* to stop the saw. **DO NOT** assume at any time that the neutral position will act as a brake. *Note: Always start the engine with the speed control lever at Neutral.*

Water Supply

The water supply cools the blade and minimizes dust when cutting. *Note: Always test the water supply for adequate pressure and flow prior to cutting.*

Using the Water Supply

1. Connect the water source hose to the dual water valve on the left side of the saw.
2. Connect one end of the water supply hose to the other water valve fitting on the left side of the saw, or to the single water valve fitting on the right side of the saw (connect hose on side being used for cutting).



Figure 13: Water Valve Fitting on Right Side of Saw

3. Connect the other end of the water supply hose to the blade guard.
4. Increase and decrease the water flow while cutting using the water valve lever on the valve connected to the water supply hose. *Note: If desired, activate the water supply just before cutting to save on water costs.*
5. Turn off the water valve lever and disconnect the water source hose from the saw when finished.
6. Disconnect the water supply hose from the blade guard and water valve fitting as necessary.

Cutting Guides

Use the cutting guides as needed to help follow the cutting line. Always check the cutting guides for proper alignment with the blade prior to cutting.

Adjusting the Front Pointer

1. Remove the lanyard from the cable cleat.
2. Lower the front pointer frame to the ground.
3. Loosen both front pointer frame screws.
4. Divide an 8–10 ft piece of string in half.
5. Place the looped end of string into a gullet on the backside of the blade.
6. Place one string line up against the backside of the blade and one string line up against the front side of the blade. Holding the string ends in one hand, tension the lines out toward the front pointer rod.

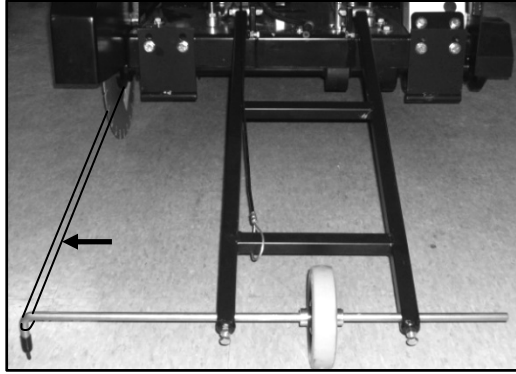

Figure 14: Tensioned String Line

7. Adjust the pointer rod to place the tip between the tensioned string lines. *Note: When aligning the pointer tip with the blade on the other side of the saw, remove both set collars and the wheel from the pointer rod and reinsert the rod into the pointer frame from the other side of the frame. Replace the wheel and set collars and secure the wheel between the frame ends.*
8. Retighten both front pointer frame screws.
9. Lift the frame off the ground when finished.
10. Tension the lanyard and secure it to the cable cleat.

Adjusting the Rear Pointer(s)

1. Loosen the rear pointer screw.
2. Adjust the orientation of the rear pointer and retighten the screw to secure.
3. Secure the pointer to the opposite side of the saw as necessary.

Concrete Cutting

! WARNING

- DO NOT expose yourself or anyone else to the direct line of the blade when operating the saw.
- The direct work area should not contain buried or embedded electrical, gas, or water lines that could be damaged and/or cause personal injury while cutting.



Note: Always raise the blade to provide proper clearance between the blade and the ground when maneuvering the saw.

Helpful Hints Prior to Cutting

Keep the following in mind for better efficiency while cutting:

- Use just enough handle pressure to guide the saw down the cutting line. DO NOT forcibly direct (twist) the saw from side to side when cutting. DO NOT jam, cock, or wedge the blade in a cut.
- Moving too quickly when cutting may stall the saw, or may cause the blade to climb out from the cut. If the saw stalls while cutting, put the saw in neutral and raise the blade from the cut to restart the engine.
- Avoid sawing excessively deep to preserve the blade and reduce sawing costs.
- DO NOT lower the blade too quickly or move the saw forward too quickly when finishing a partial-cut to avoid forcing the blade into the concrete.
- Always have a proper water flow when cutting for maximum blade efficiency. Using too much water when cutting will make the slurry look clear. Not using enough water will make the slurry look thick and pasty.
- Refer to the Diamond Products' Guide for Professional Concrete Cutters for additional cutting tips and information.

Tasks Prior to Cutting

Complete the following tasks prior to cutting:

- Align the cutting guide(s) with the blade.
- Clearly mark the cutting line.
- Turn off all electricity, gas, and water around the direct work area.

Making a Cut

1. Align the blade and cutting guide(s) with the cutting line.
2. Turn on the water and adjust the water flow.
3. Turn on the *Water Safety* switch.
4. Turn on the *Water Pump* switch if needed.
5. Lower the blade to just above the cutting surface and set the cutting depth indicator at zero.

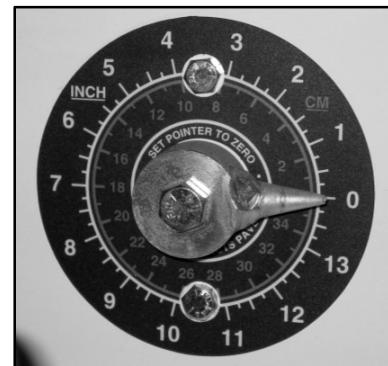

Figure 15: Cutting Depth Indicator

6. Slowly lower the blade into the concrete surface to a depth of two inches for the initial cut. Make the two-inch deep pass across the entire cutting line using the most efficient blade speed and traveling speed. DO NOT cut to the maximum depth in one pass.
Note: Always use the step-cut method when cutting for maximum efficiency. For example, when cutting to a depth of ten inches, begin with a two-inch deep pass, then a four-inch deep pass, and finish with another four-inch deep pass to complete the cut.
7. Raise the blade out of the cut and reposition the saw at the end of the cut. DO NOT move backwards in a previous cut.
8. Starting at the end of the cut, lower the blade back into the cut and make another two-inch deep pass or a deeper pass across the entire cutting line. *Note: When not using the depth stop, pay attention to the cutting depth indicator at all times when lowering the blade back into the cut or when making a new cut, as the blade will not automatically stop at the desired depth.*
9. Raise the blade out of the cut, reposition the saw, and continue the step-cut process to reach the maximum depth. DO NOT cut any deeper than required.
8. Make the two-inch deep pass across the entire cutting line using the most efficient blade speed and traveling speed. DO NOT cut to the maximum depth in one pass. *Note: Always use the step-cut method when cutting for maximum efficiency. For example, when cutting to a depth of ten inches, begin with a two-inch deep pass, then a four-inch deep pass, and finish with another four-inch deep pass to complete the cut.*
9. Raise the blade out of the cut and reposition the saw at the end of the cut. DO NOT move backwards in a previous cut.
10. Starting at the end of the cut, lower the blade back into the cut and make another two-inch deep pass across the entire cutting line, or readjust the depth stop to make a deeper pass following step 11. *Note: When repeating a depth using the depth stop, the blade will not cut any deeper than the current depth stop setting.*
11. Turn the *Blade Depth Stop* knob counterclockwise to increase the cutting depth or clockwise to decrease the cutting depth to set the cutting depth at a different depth. *Note: When increasing the cutting depth, the depth stop knob will stop turning when the saw has reached its maximum cutting depth.*
12. Continue the step-cut process using the *Blade Depth Stop* to reach the maximum depth. DO NOT cut any deeper than required.

Making a Cut Using the Blade Depth Stop

1. Align the blade and cutting guide(s) with the cutting line.
2. Turn on the water and adjust the water flow.
3. Turn on the *Water Safety* switch.
4. Turn on the *Water Pump* switch if needed.
5. Lower the blade to just above the cutting surface and set the cutting depth indicator at zero.
6. Slowly lower the blade into the concrete surface to a depth of two inches for the initial cut.
7. Turn the *Blade Depth Stop* knob clockwise until resistance is felt, which means the cutting depth is set.



Figure 16: Blade Depth Stop

Continuing a Partial-Cut

1. Maneuver the saw to the desired location.
2. Align the blade with the previous cut and slowly lower the blade back into the concrete. Use extreme caution to make sure the blade is perfectly aligned within the cut. DO NOT continue cutting until the blade is aligned within the cut!
3. Continue the step-cut process (using the *Blade Depth Stop* if preferred) to reach the maximum depth. DO NOT cut any deeper than required.

Finishing a Cut

1. Place the speed control lever at *Neutral*.
2. Raise the blade from the cut (provide proper ground clearance).
3. Turn off the *Water Pump* switch and *Water Safety* switch.
4. Turn off the water supply.

Maintaining the CC3500J

Failure to read and comply with the maintenance instructions provided in this manual prior to performing maintenance may result in serious injuries and/or death, and may harm the saw. DO NOT attempt to perform maintenance on the saw if you are not properly trained for it, or are not supervised by an experienced person.

Refer to the CC3500J Parts List for additional information and part diagrams when performing maintenance tasks. Refer to the engine manual and manufacturer as the primary source for all safety, operations, and maintenance instructions for the engine. Contact the saw and/or engine manufacturer with any additional questions.

Remove all necessary guards and access panels prior to servicing the saw. Replace prior to operating.

Maintenance Overview

Complete the following tasks as required. DO NOT delay maintenance! Print the Daily Maintenance Task Chart from Appendix B to help keep track of maintenance tasks completed daily.

Daily

- Lubricate the blade shaft bearing grease fittings (2).
- Inspect the saw for damages and repair.
- Tighten loose nuts, screws, and bolts.
- Check all fluid levels (fuel, engine oil, transmission fluid) and fill as necessary.
- Wipe down and clean all saw components to remove dust, debris, and slurry (especially from fans).
- Inspect all belts for tension and wear. Replace or tension as necessary.
- Clean the air cleaner (see engine manual).
- Look for fluid leaks and check all hoses. Repair all damaged components.
- Tension the rear drive chain as necessary.
- Make sure the skid plates are connected to the frame base through the bottom holes on the plate.

40 Hours

- Lubricate the rear drive chain.

100 Hours

- Lubricate the jackshaft bearing grease fittings (4).
- Lubricate the front axle weldment grease fitting (1).
- Lubricate the front axle bearing grease fittings (2).
- Lubricate the rear axle bearing grease fittings (2).
- Lubricate the transmission jackshaft bearing grease fittings (2).

- Lubricate the hydraulic lift cylinder grease fitting (1).
- Lubricate the linkage assembly grease fittings (6).
- Lubricate the front wheel grease fittings (2).

250 Hours

- Change the hydraulic oil filter (replace once after first 50 hours, then as scheduled).
- Change the in-line fuel filter if necessary.

Note: Refer to the engine manual and manufacturer for a list of routine engine maintenance tasks.

Part Lubrication



WARNING

- DO NOT grease parts with the engine running (unless stated otherwise).



Lubricate all necessary parts on schedule for maximum saw efficiency. Occasionally lubricate controls, cables, and linkages with a spray lubricant when movement becomes stiff and/or sluggish. Use one to two full pumps of NLGI No. 2 premium, lithium-based grease when lubricating all grease fittings. *Note: Use more grease on bearing grease fittings if they are too hot to touch after completing work.*

Inner Blade Flange

Installing the Inner Blade Flange

1. Inspect the inner flange for damages. Clean or replace damaged components as necessary.
2. Align the flange with the blade shaft key and place the flange onto the blade shaft.
3. Apply Loctite 262 (red) or an equivalent to the setscrew threads.
4. Tighten the setscrew(s) into the back of the inner flange to secure.

Removing the Inner Blade Flange

1. Remove the setscrew(s) from the back of the inner flange using an Allen wrench.
2. Carefully remove the flange from the blade shaft.

Drive Alignment

Adjust the rear axle when the saw's drive alignment is off (saw will not cut in a straight line). *Note: The rear axle can be adjusted based on preference.*

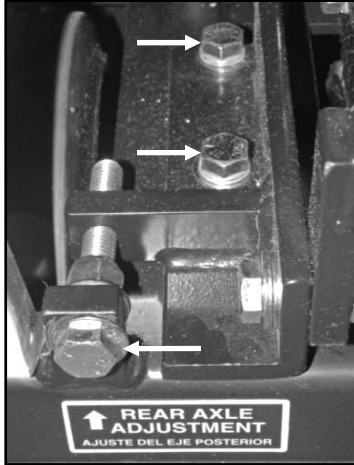

Figure 17: Rear Axle Bearing Screws and Adjustment Bolt

1. Loosen the two left rear axle bearing screws.
2. Loosen the hex nut on the rear axle adjustment bolt.
3. Turn the adjustment bolt clockwise to adjust the drive alignment toward the left, or counterclockwise to adjust the drive alignment toward the right.
4. Retighten the hex nut on the adjustment bolt.
5. Retighten the two left rear axle bearing screws.

Wheels

WARNING

- Raise the saw to a proper height for access when working underneath the saw. Use chocks to block the wheels, and fit blocks or jacks under the frame edges at the front and back of the frame for additional support.



Replacing the Front Wheels

Replace the front wheels when damaged and/or affecting saw performance.

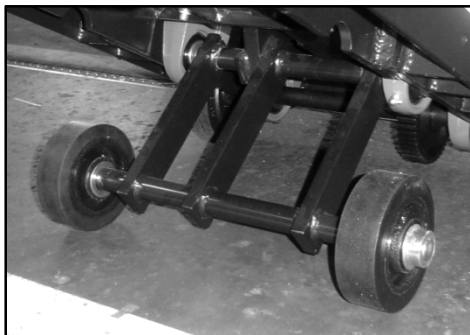

Figure 18: Front Wheels

1. Move the saw to level ground. Use a jack to lift the front wheels off the ground.
2. Remove the setscrew from the set collar and remove the set collar.
3. Remove the wheel and flat washers from the front axle.
4. Place a flat washer and then a new wheel onto the front axle.
5. Place a flat washer and then the set collar up against the wheel on the front axle. Retighten the setscrew into the set collar to secure.
6. Replace the second front wheel as directed above.
7. Slowly lower the jack and remove the jack stand when the wheels are firmly touching the ground.

Replacing the Rear Wheels

Replace the rear wheels when damaged and/or affecting saw performance.





Figure 19: Rear Wheel

1. Move the saw to level ground. Use a jack to lift the rear wheels off the ground.
2. Remove the three screws from the wheel.
3. Remove the wheel mount washer and wheel from the rear axle.
4. Place a new wheel onto the rear axle.
5. Replace the wheel mount washer and retighten the three screws to secure the wheel.
6. Replace the second rear wheel as directed above.
7. Slowly lower the jack and remove the jack stand when the wheels are firmly touching the ground.

Battery

WARNING

- Ignitable explosive gases are emitted from the battery. DO NOT expose the battery to sparks or open flames, and keep the area around the battery well-ventilated. 
- Disconnect the battery prior to servicing the saw (unless stated otherwise).
- Always keep the battery cable clamps away from the battery terminals when the battery is disconnected to avoid accidental connections while servicing. 
- Always be sure to connect the battery cables to the proper terminal when reconnecting.

CAUTION

- Use a proper battery tester when testing the battery strength.
- Use protective eyewear or a face shield and avoid contact with the skin when handling/servicing the battery.

The saw contains a charged battery with one positive cable lead and one negative cable lead.



Figure 20: Battery

Battery Type

12 Volt, Group 34

Servicing the Battery

1. Remove the battery top brace.
2. Remove the negative battery boot and disconnect the negative cable lead from the negative terminal.
Note: Always disconnect the negative cable first.

3. Remove the positive battery boot and disconnect the positive cable lead from the positive terminal.
4. Carefully remove the battery from the battery platform.
5. When replacing the battery, carefully place a new battery onto the battery platform. Bring the old battery to a recycling facility; many battery retailers also accept old batteries.
6. When cleaning the battery, inspect the terminals, clamps, and cables for damages and corrosion. Clean the terminals and clamps using a wire brush, or use another approved technique for cleaning. Use acid-free, acid-resistant grease to grease the battery clamps and terminals. Carefully place the battery back onto the battery platform.
7. Reconnect the positive cable lead to the positive battery terminal and replace the battery boot. *Note: Always reconnect the positive cable first.*
8. Reconnect the negative cable lead to the negative battery terminal and replace the battery boot.
9. Replace the battery top brace and secure.

Speed Control Lever

Adjusting the Speed Control Lever Linkage

Adjust the speed control lever linkage when it is set incorrectly; for example, when the saw is in neutral, but the lever is closer to the forward or reverse position.

1. Start the engine and move the speed control lever forward or backward to find the neutral position.
Note: The saw should not move at all.
2. Stop the engine.
3. Disconnect the 10-1/2" linkage (pg 21, item 12 in CC3500J Parts List) from the bell crank. *Note: DO NOT move the 7-3/4" linkage (pg 21, item 11 in CC3500J Parts List) when disconnecting the 10-1/2" linkage to keep the saw in the neutral position.*
4. Loosen the threaded rod nuts on the 10-1/2" linkage.
5. Turn the threaded rod to either lengthen or shorten the linkage, which will move the speed control lever toward the neutral position on the control panel.
6. When the speed control lever is in the neutral position on the control panel, retighten the threaded rod nuts on the 10-1/2" linkage.
7. Reconnect the 10-1/2" linkage to the bell crank. DO NOT move the 7-3/4" linkage.
8. Remove all tools from the area. Start the engine to check the speed control lever for accuracy.
9. If the speed control lever is still not properly aligned, repeat step 1–8 to readjust.

Adjusting the Speed Control Lever Friction

Adjust the screw and nut on the speed control lever (through friction spacer) to change the amount of friction felt when moving the lever forward or backward. Loosen

the bolt a small amount to make it easier to move the lever, or tighten the bolt a small amount to make it harder to move the lever.

Magnetic Sensor (Optional)

The magnetic sensor transfers the blade speed to the blade shaft tachometer. Adjust or replace the magnetic sensor if the tachometer reading remains at zero while operating the saw.

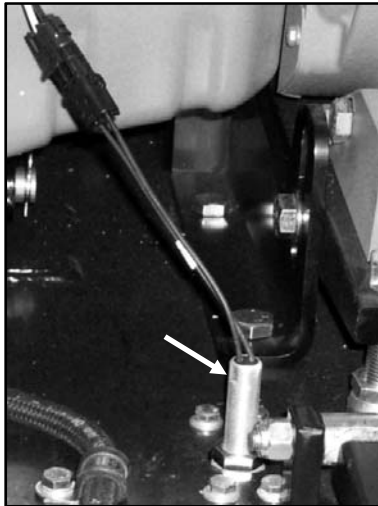

Figure 21: Magnetic Sensor

Adjusting the Magnetic Sensor

1. Loosen the jam nut on the magnetic sensor.
2. Turn the magnetic sensor clockwise to screw the sensor in until it bottoms out (stops).
3. Turn the sensor counterclockwise exactly one-half turn.
4. Retighten the jam nut down to the frame base to secure.
5. Test the tachometer and replace if it is still not working properly.

Replacing the Magnetic Sensor

1. Disconnect the battery.
2. Disconnect the tachometer sensor wire harness.
3. Loosen the jam nut on the magnetic sensor and turn the sensor counterclockwise to remove it.
4. Turn the new magnetic sensor's jam nut counterclockwise to place the nut near the top of the sensor.
5. Fit the sensor into the center of the shaft tachometer gear guard through the hole on the frame base.
6. Turn the magnetic sensor clockwise until it bottoms out (stops).
7. Turn the sensor counterclockwise exactly one-half turn.

8. Retighten the jam nut down to the frame base to secure.
9. Reconnect the tachometer sensor wire harness.
10. Reconnect the battery.
11. Test the tachometer and readjust as necessary.

Electrical System

! WARNING

- Disconnect the battery when servicing the electrical system unless stated otherwise.
- Always use the correct size fuses (amps) to prevent fires.



Inspect all fuses if switches or controls are not working properly and replace as necessary. If fuses are failing frequently, determine the cause and repair immediately. Refer to the CC3500J Parts List for electrical diagrams.

Transmission

Cooling Fan

Wipe down or use compressed air to clean dust, debris, and slurry from the transmission cooling fan daily. *Note: Failure to clean the cooling fan will not allow the transmission oil to cool properly.*

Adding Fluid

Check the transmission fluid daily (through the hydraulic pump unit) and add DEXRON III automatic transmission fluid, following the directions in the *Hydraulic System* section, as necessary.

Tightening the Rear Drive Chain

Inspect the rear drive chain daily and tighten as necessary. Lubricate the chain every 40 hours with Mobil ATF D/M oil to reduce chain wear.

1. Loosen the nut on the four screws securing the transmission to the transmission platform.
2. Loosen the setscrew hex nut at the midpoint of the transmission platform.

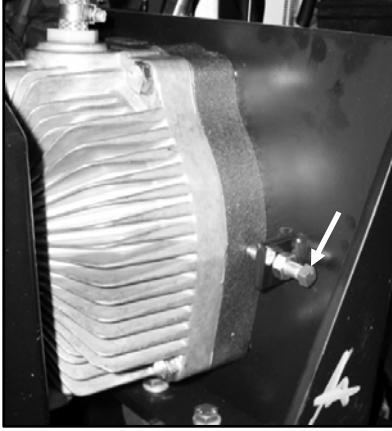

Figure 22: Transmission Setscrew

3. Turn the setscrew clockwise to push the transmission forward in the platform slots. Leave a little bit of slack in the chain, and DO NOT over-tighten it.
4. Retighten the hex nut to secure the transmission setscrew.
5. Retighten the nut to the four screws to secure the transmission to the transmission platform.
6. Once the drive chain is tensioned, check the transmission belt for proper alignment and tension, and adjust as necessary.

Hydraulic System

WARNING

- Always place a piece of cardboard or paper up against hydraulic components, or use a leak detection fluid to check for hydraulic fluid leaks. Keep all body parts away from leaks and/or areas that may eject hydraulic fluid. Pressurized hydraulic fluid can penetrate the skin, causing serious injuries. Seek medical attention immediately!
- Always make sure any hydraulic components being serviced are not supporting the weight of other saw components. If a particular component is under pressure when connections points are loosened, oil may spray out forcefully.



Inspect all hydraulic hoses and fittings daily for leaks. Remember to use cardboard or a piece of paper when checking for leaks and replace damaged components immediately.

Adding Fluid to the Hydraulic Lift Pump

Check the hydraulic fluid daily and add fluid to the pump as necessary.

1. Lower the saw to level the frame.
2. Remove the taller hydraulic pump breather cap.
3. Add DEXRON III automatic transmission fluid to just below where the taller fill port extends from the hydraulic pump unit. Remove the second fill cap for the tank and check the fluid level using the dipstick connected to the cap. *Note: Filling fluid to the port opening will cause leakage through the breather cap when lowering the saw.*
4. Replace the breather cap and retighten to secure.

Belt Sheaves

The belt sheaves may need to be changed when changing the blade size. Refer to the CC3500J Parts List for additional information. *Note: All belts must be removed prior to changing the sheaves.*

Changing the Belt Sheaves

Small Jackshaft Sheave (14"-26") and Large Jackshaft Sheave

1. Remove both setscrews from the front of the bushing.
2. Place one of the removed setscrews into the third setscrew hole (in line with slot) on the bushing. Using a 1/2" impact wrench, tighten the setscrew into the hole to separate the sheave from the bushing. If the sheave and bushing will not separate, wedge a flat-head screwdriver into the slot on the bushing and tap the other end of the screwdriver with a rubber mallet to separate the sheave and bushing.
3. Remove the sheave and bushing.
4. Remove the setscrew used to separate the sheave and bushing.
5. Fit the appropriate size bushing and sheave together and slide them onto the jackshaft. *Note: Align the bushing with the jackshaft key in place on the shaft prior to installing, or drive the key into the key hole once the sheave and bushing are fully installed.*
6. Place the two setscrews into the setscrew holes (in line with each other) on the bushing and retighten the setscrews to secure the bushing and sheave.

Small Jackshaft Sheave (30"), Blade Shaft Sheave, Transmission Sheave, and Engine Sheave

Make sure the sheaves are properly aligned prior to securing them. *Note: Remove the inner blade flange prior to removing the blade shaft sheave.*

1. Remove the four setscrews (two on transmission sheave) from the sheave grooves.

2. Remove the sheave. *Note: The transmission sheave must be removed prior to removing the engine sheave.*
3. Align the appropriate size sheave with the drive key and fit the sheave onto the shaft. *Note: If desired, drive the key into the key hole once the sheave is fully installed.*
4. Place the four setscrews (two on transmission sheave) into the setscrew holes in the sheave grooves, and retighten the setscrews to secure the sheave. *Note: The engine sheave must be installed prior to installing the transmission sheave.*

Aligning the Belt Sheaves

Always align the large jackshaft sheave with the engine sheave, and the small jackshaft sheave with the blade shaft sheave prior to securing the sheaves in place.

- Use a straightedge (use skinny side of straightedge for least amount of bending) and place it against the outside edge of one of the sheaves. Adjust either or both sheaves for alignment and secure in place.

Belt System

! WARNING

- Turn off the engine prior to servicing the belts.
- Use extreme caution when working with belts and rotating machine parts to avoid entanglement.



! CAUTION

- Let the belts cool down prior to servicing them.

Inspect all belts daily for fraying, stress cracks, and/or breakage and replace immediately when damaged. Always re-tension new belts after the first four hours of use. **DO NOT** exceed the manufacturer's recommended belt tension settings when tensioning belts. *Note: Overtensioning belts may damage the crankshaft. Undertensioning belts may cause slippage, shorter belt life, and/or poor saw performance. Squealing belts indicate looseness.*

Tensioning/Replacing the Blade Drive Belts

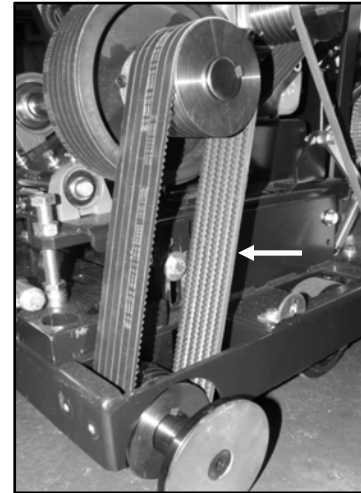

Figure 23: Blade Drive Belts

1. Test the belt tension. Refer to Appendix C for additional information on belt tension settings.
2. Loosen the four engine mount screws. If tensioning the belts, proceed with steps 7–9. If replacing the belts, continue with steps 3–9.
3. Loosen the nut on both blade drive belt tension bolts.
4. Turn both blade drive belt tension bolts (large threaded bolts on engine base) counterclockwise to loosen the belts.

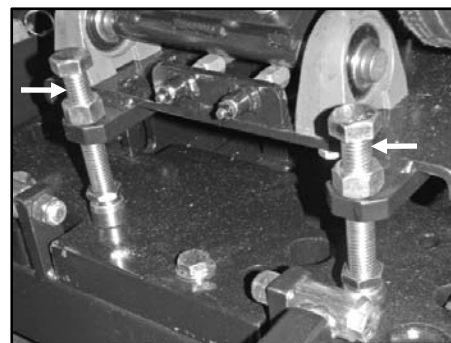

Figure 24: Belt Tension Bolt

5. Remove the matched set of belts from the blade shaft sheave and front jackshaft sheave.
6. Loop and align a new matched set of belts around the blade shaft sheave and front jackshaft sheave.

7. Turn both blade drive belt tension bolts (large threaded bolts on engine foot) clockwise equally to tighten the belts (if tensioning belts only, loosen the nut on both bolts prior to adjusting the bolts). Test the belt tension and readjust the bolts as necessary. Refer to Appendix C for additional information on belt tension settings. DO NOT exceed the manufacturer's tension settings.
8. Tighten the nut on both blade drive belt tension bolts.
9. Retighten the four engine mount screws.

Tensioning/Replacing the Jackshaft Belts

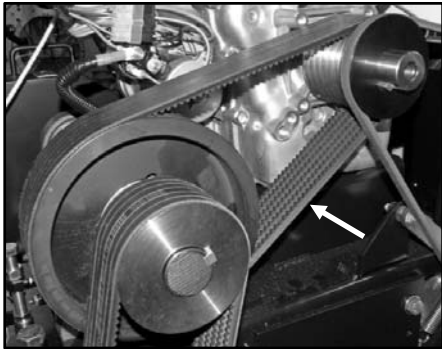

Figure 25: Jackshaft Belts

1. Test the belt tension. Refer to Appendix C for additional information on belt tension settings.
2. Loosen the four engine mount screws and loosen the blade drive belts.
3. Loosen the two jackshaft mount screws. If tensioning the belts, proceed with steps 10–14. If replacing the belts, continue with steps 4–15.
4. Remove the transmission drive belt.
5. Remove the blade drive belts.
6. Loosen the nut on the jackshaft belt tension bolt.
7. Turn the jackshaft belt tension bolt (large threaded bolt on jackshaft mount) counterclockwise to loosen the belts.

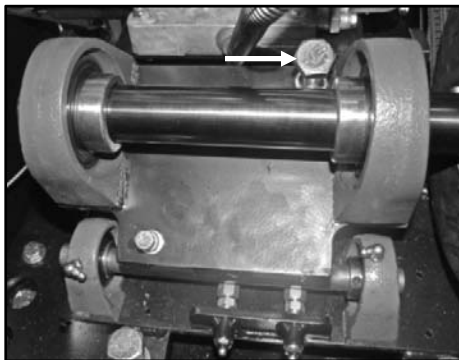

Figure 26: Jackshaft Tension Bolt

8. Remove the matched set of belts from the rear jackshaft sheave and engine sheave.
9. Loop and align a new matched set of belts around the rear jackshaft sheave and engine sheave.
10. Turn the jackshaft belt tension bolt (large threaded bolt on jackshaft mount) clockwise to tighten the belts (if tensioning belts only, loosen the nut on the bolt prior to adjusting the bolt). Test the belt tension and readjust the bolt as necessary. Refer to Appendix C for additional information on belt tension settings. DO NOT exceed the manufacturer's tension settings.
11. Tighten the nut on the jackshaft belt tension bolt.
12. Retighten the two jackshaft mount screws.
13. Reinstall (if necessary) and tension the blade drive belts.
14. Retighten the four engine mount screws.
15. Reinstall the transmission drive belt.

Replacing the Transmission Drive Belt

Replace the idler pulley spring when the transmission drive belt begins slipping during normal operation, or when the spring becomes overstretched, not allowing the belt to be fully tightened.

1. Lift up the idler arm and remove the transmission drive belt. Gently release the arm.
2. Loop and align a new belt around the engine sheave and transmission sheave.
3. Lift up the idler arm and loop the belt under the idler pulley. Gently release the arm to tension the belt.

In-Line Fuel Filter

Change the in-line fuel filter every 250 to 500 hours, depending on the amount of buildup in the filter.

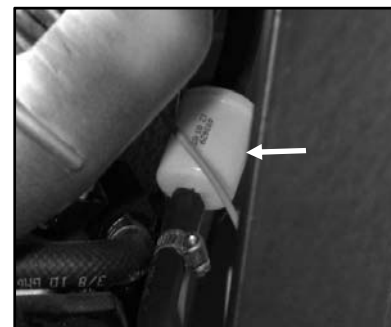

Figure 27: In-Line Fuel Filter



1. Lower the saw completely.
2. Close the fuel shutoff valve.
3. Place a drain pan under the hoses and in-line filter.
4. Remove the hose clamp from both sides of the filter.

5. Remove the filter from the hoses. Drain any escaping fuel and dispose of the used fuel and filter according to city, state, and federal regulations.
6. Place the fuel hose coming from the fuel tank onto the end of the filter (the arrow on the filter should not point toward this hose). Push the hose tightly up against the edge of the filter and secure with the hose clamp.
7. Place the fuel hose coming from the engine onto the other end of the filter (the arrow on the filter should point toward this hose). Push the hose tightly up against the edge of the filter and secure with the hose clamp.
8. Open the fuel shutoff valve.

maintaining. Complete the tasks listed below when discontinuing usage:

- Drain all fluids and dispose of according to city, state, and federal regulations.
- Remove the battery and bring to a recycling facility; many battery retailers also accept old batteries.
- Transport the saw to a salvage yard or recycling facility.

Engine

	<p>WARNING</p> <ul style="list-style-type: none"> • Let the engine cool down prior to servicing the saw. • DO NOT service the saw with the engine running (unless stated otherwise). 	
---	---	---

Refer to the engine manual and manufacturer for a full engine maintenance schedule and additional engine maintenance information.

Cleaning the Engine

Clean and wipe down the engine's exterior, fans, and guards daily to prevent high operating temperatures.

Storing

Complete the tasks listed below prior to storing the saw for longer time frames:

- Drain the water lines/hoses.
- Turn off all switches and controls.
- Lower the saw completely to remove strain on the lifting mechanism.
- Clean and wipe down the saw to remove dust, debris, and slurry from saw components (especially fans).
- Remove the battery and store in a proper location, out of reach from children.
- Refer to the engine manual for all engine and fuel recommendations prior to storing.
- Store the saw in a dry area, protected from outdoor elements and out of reach from children.

Disposal

Dispose of the saw when it's no longer repairable, and/or contains safety hazards not worth repairing or

References

Appendix A

Serial Tags

Record the saw's serial number below for future reference and customer service purposes.

Serial Number	
---------------	--

Record the engine's model and serial numbers below for future reference and customer service purposes.

Model Number	
Serial Number	

Appendix B

Daily Maintenance Task Chart

Table 4: Daily Maintenance Task Chart							
Date							
		✓	✓	✓	✓	✓	✓
1.	Lubricate the blade shaft bearing grease fittings (2).						
2.	Inspect the saw for damages and repair.						
3.	Tighten loose nuts, screws, and bolts.						
4.	Check all fluid levels (fuel, engine oil, transmission fluid) and fill as necessary.						
5.	Wipe down and clean all saw components to remove dust, debris, and slurry (especially from fans).						
6.	Inspect all belts for tension and wear. Replace or tension as necessary.						
7.	Clean the air cleaner (see engine manual).						
8.	Look for fluid leaks and check all hoses. Repair all damaged components.						
9.	Tension the rear drive chain as necessary.						
10.	Make sure the skid plates are connected to the frame base through the bottom holes on the plate.						
11.	Refer to the engine manual and manufacturer for daily engine care and routine maintenance tasks.						

Appendix C

Belt Tension Settings

Table 5: Belt Tension Settings											
Model	Engine Type	Belt	Belt ID	Blade Size	Deflection Force (lb)		Deflection (in.)		Sonic Tension Meter (Hz)		
					New Belts	Used Belts	New Belts	Used Belts	New Belts	Used Belts	
CC3500J	Briggs & Stratton Vanguard 540000	Jackshaft to Blade Shaft	3VX400	14"	4.7-5.0	4.0-4.3	.21	.21	107-111	99-103	
				20"	5.5-5.8	4.7-5.1	.20	.20	121-125	112-117	
				26"	5.2-5.6	4.5-4.96	.20	.20	115-119	107-111	
				30"	5.1-5.5	4.4-4.8	.21	.21	109-113	101-105	
		Engine to Jackshaft	3VX355	14"	5.0-5.3	4.3-4.7	.19	.19	119-123	110-115	
				3VX400	20"	5.3-5.6	4.5-4.9	.16	.16	145-150	134-140
					26"	5.3-5.6	4.5-4.9	.16	.16	145-150	134-140
					30"	5.3-5.6	4.5-4.9	.16	.16	145-150	134-140

Table 6: Belt Tension Settings											
Model	Engine Type	Belt	Belt ID	Blade Size	Deflection Force (lb)		Deflection (in.)		Sonic Tension Meter (Hz)		
					New Belts	Used Belts	New Belts	Used Belts	New Belts	Used Belts	
CC3500J	Kohler CH1000	Jackshaft to Blade Shaft	3VX400	14"	5.3-5.6	4.5-4.9	.21	.21	114-118	106-110	
				20"	5.2-5.6	4.5-4.9	.20	.20	118-123	110-114	
				26"	5.1-5.5	4.4-4.8	.20	.20	114-118	106-110	
				30"	5.8-6.2	5.0-5.4	.21	.21	117-121	108-113	
		Engine to Jackshaft	3VX355	14"	4.6-4.9	4.0-4.3	.19	.19	114-118	106-110	
				3VX400	20"	4.9-5.2	4.2-4.5	.16	.16	139-144	129-134
					26"	4.9-5.2	4.2-4.5	.16	.16	139-144	129-134
					30"	4.9-5.2	4.2-4.5	.16	.16	139-144	129-134

Appendix D

Troubleshooting

Table 7: Troubleshooting		
Symptom	Problem	Solution
1. Engine will not start.	Out of fuel?	Fill fuel tank.
	Emergency stop button down?	Pull up emergency stop button.
	Fuel lines clogged?	Unclog or replace fuel lines.
	Air in fuel lines?	Bleed fuel lines.
	Worn-out battery?	Charge or replace battery.
	Faulty battery connection?	Inspect, clean, and tighten battery cables.
	Engine malfunction?	Refer to engine manual.
2. Saw will not raise.	Defective solenoid start switch?	Replace solenoid on hydraulic pump unit.
	Worn-out battery?	Charge or replace battery.
	Defective raise button?	Replace raise button.
3. Saw will not lower.	Debris in lowering valve stem?	Inspect and clean stem.
	Worn-out battery?	Charge or replace battery.
	Defective valve coil?	Check for magnetism of valve stem when activated.
	Defective lowering button?	Replace lowering button.
4. Saw will not completely lower.	Depth stop set?	Reset depth stop.
	Skid plates in wrong set of holes?	Use correct set of holes on skid plate.
5. Saw lowers too slow/too fast.	Improper lowering speed setting?	Adjust blade lowering speed valve.
6. Blade does not cut straight.	Drive alignment off?	Adjust rear axle adjustment bolt.
	Excessive force used when sawing?	Reduce forward speed. DO NOT twist blade from side-to-side.
	Wrong blade?	Contact dealer/manufacturer of blade.
7. Short belt life.	Loose belts causing slippage?	Check belt tension.
	Sheaves misaligned?	Use straightedge to check sheave alignment.
	Worn sheave grooves?	Check for groove wear and replace sheaves when necessary.
	Mismatched belts?	Replace with matched set of belts. DO NOT use old and new belts together.

Appendix E

Additional Resources

1. Briggs & Stratton (www.briggsandstratton.com)
 - *Operating & Maintenance Instructions Model 540000 Vanguard, Model 610000 Vanguard; Wisconsin, 2007*
2. Kohler Command Pro (www.kohlerengines.com)
 - *Owner's Manual CH940-CH1000; Wisconsin, 2009*
3. Diamond Products (www.diamondproducts.com)
 - *CC3500J Concrete Saw Parts List; Ohio, 2010*
 - *A Guide for Professional Concrete Cutters*
 - *Training Manual – Introduction to Diamond Blades, Bits, and Equipment*
 - *Diamond Products' Equipment Catalog*
 - *Diamond Products' Website*
4. Concrete Sawing and Drilling Association (www.csda.org)
 - The CSDA has many helpful concrete cutting publications available to members and non-members.
5. Association of Equipment Manufacturers (www.aem.org)
 - The AEM has a variety of safety and technical manuals available for various types of equipment, along with a list of industry-standardized safety symbols.
6. Occupational Safety & Health Administration (OSHA) (www.osha.gov/)
 - OSHA provides information on work-related safety and health practices.
7. The National Institute for Occupational Safety and Health (NIOSH) (www.cdc.gov/NIOSH/)
 - NIOSH provides information on work-related safety and health practices.

Notes:

Notes:

